

COBHAM

EXPLORER 710

User manual



Document number: 98-140012-H

Release date: 11 February 2021

Disclaimer

Any responsibility or liability for loss or damage in connection with the use of this product and the accompanying documentation is disclaimed by Thrane & Thrane A/S. The information in this manual is provided for information purposes only, is subject to change without notice and may contain errors or inaccuracies. Manuals issued by Thrane & Thrane A/S are periodically revised and updated. Anyone relying on this information should acquire the most current version e.g. from www.cobhamsatcom.com, **Cobham SYNC Partner Portal**, or from the distributor. Thrane & Thrane A/S is not responsible for the content or accuracy of any translations or reproductions, in whole or in part, of this manual from any other source. In the event of any discrepancies, the English version shall be the governing text.

Thrane & Thrane A/S is trading as Cobham SATCOM.

Copyright

© 2021 Thrane & Thrane A/S. All rights reserved.

Manufacturer address

Thrane & Thrane A/S, Lundtoftegaardsvej 93 D, DK-2800, Kgs. Lyngby, Denmark

Trademark acknowledgments

- **Inmarsat** is a registered trademark of the International Maritime Satellite Organisation (IMSO) and is licensed by IMSO to Inmarsat Limited and Inmarsat Ventures plc.
- Other product and company names mentioned in this manual may be trademarks or trade names of their respective owners.

Safety summary

The following general safety precautions must be observed during all phases of operation, service and repair of this equipment. Failure to comply with these precautions or with specific warnings elsewhere in this manual violates safety standards of design, manufacture and intended use of the equipment. Thrane & Thrane A/S assumes no liability for the customer's failure to comply with these requirements.

Do not operate in an explosive atmosphere

Do not operate the equipment in the presence of flammable gases or fumes. Operation of any electrical equipment in such an environment constitutes a definite safety hazard.

Keep away from live circuits

Operating personnel must not remove equipment covers. Component replacement and internal adjustment must be made by qualified maintenance personnel. Do not replace components with the power cable connected. Under certain conditions, dangerous voltages may exist even with the power cable removed. To avoid injuries, always disconnect power and discharge circuits before touching them.

Do not service alone

Do not attempt internal service or adjustments unless another person, capable of rendering first aid resuscitation, is present.

Do not substitute parts or modify equipment

Because of the danger of introducing additional hazards, do not substitute parts or perform any unauthorized modification to the equipment.

Keep away from antenna front

This device emits radio frequency energy when switched on. To avoid injury, keep a minimum safety distance of 1 m from the antenna front when the EXPLORER 710 is on.

For information on the safety distance from the transceiver (WLAN), see the *FCC/IC Radiation Exposure statement* on the next page.



Garder à l'écart de l'avant de l'antenne

Le présent appareil émet des radiofréquences lors de son utilisation. Afin d'éviter tout risque pour la santé, une distance minimale de 1 m est nécessaire entre l'utilisateur et l'avant de l'EXPLORER 710.

Pour plus d'informations à propos de la distance de sécurité avec l'appareil (WLAN), veuillez consulter *Déclaration de l'IC sur l'exposition aux radiations* sur la page suivante.

Only use approved batteries from Cobham SATCOM

Use of non approved batteries may result in explosion, fire, electrical shock or injury.

Observe marked areas

Under extreme heat conditions do not touch areas of the EXPLORER 710 that are marked with this symbol, as it may result in injury.

The terminal has been designed for full usability meaning that there are no restrictions to which interfaces can be used simultaneously. This means that you can use all the interfaces at once at any temperature within -25 to 55 °C. Be aware that the terminal will get very hot when it is operated at 55 °C with all interfaces active and it is therefore marked with a heating label.



FCC/IC Radiation Exposure statement

WLAN: Transceiver Unit (when separated from the Antenna Unit):

This equipment complies with FCC and IC radiation exposure limits for an uncontrolled environment. This equipment should be installed and operated at a distance greater than 20 centimeters (8 inches) between the transceiver unit and yourself or any bystander to comply with the Radiation Exposure Requirements.

Déclaration de l'IC sur l'exposition aux radiations

WLAN: L'émetteur-récepteur (quand séparé de l'antenne) :

Le présent appareil est conforme aux limites de l'IC sur l'exposition aux rayonnements établies pour un environnement non-contrôlé. Le présent appareil doit être installé et utilisé à une distance minimum de 20 centimètres (8 pouces) entre l'émetteur-récepteur et l'utilisateur ou tout autre individu pour être conforme à la réglementation en matière d'exposition radiologique.

Safety note from battery supplier

Korean text:

전지

경고 : 발열, 화재, 폭발등의 위험을 수반할 수 있으니 다음 사항을 지켜주시기 바랍니다.

- 화기에 가까이 하지 말 것
- 분해, 압착, 관통 등의 행위를 하지 말 것
- 높은 곳에서 떨어뜨리는 등 비정상적 충격을 주지 말 것
- 전지 단자에 목걸이, 동전, 열쇠, 시계 등 금속 제품이 닿지 않도록 주의할 것 (휴대컴퓨터용 전지가 아닌 경우 생략 가능)
- 60°C 이상의 고온에 노출하지 말 것

휴대 기기, 제조업체가 보증한 리튬 2 차전지 사용할 것

English translation:

Battery

Warning: Hazards such as high temperature, fire or explosion can happen. To avoid such hazards, observe the following directions and recommendations.

- Keep away from fire.
- Do not disassemble, break or penetrate the battery.
- Do not drop the battery.
- Do not touch the terminals of the battery with conductive materials such as coins, keys, watches etc.
- Do not expose the battery to temperatures above 60 °C.
- Only use Li-Ion batteries that are approved by the manufacturer.

Antenna safety instructions

Use only manufacturer supplied antennas.

Antenna minimum safe distance: 1 m

Antenna gain

Directional, with maximum gain of 14.6 dB with reference to isotropic.

The Federal Communications Commission has adopted a safety standard for human exposure to RF (Radio Frequency) energy which is below the OSHA (Occupational Safety and Health Act) limits.

Antenna mounting

The antenna supplied by the manufacturer must be located such that during radio transmission, no person or persons can come closer than the above indicated minimum safe distance to the front face of the antenna, i.e. 1 m.

L'antenne fournie par le fabricant doit être placée de telle sorte que, durant les transmissions radio, personne ni aucun groupe de personnes ne puisse s'approcher à une distance inférieure à la distance de sécurité minimal indiquée ci-dessus, c.-à-d., 1 m.

To comply with current FCC RF Exposure limits, the antenna must be installed at or exceeding the minimum safe distance shown above, and in accordance with the requirements of the antenna manufacturer or supplier.

Antenna substitution

Do not use any other antenna than the models supplied or recommended by the manufacturer. You may be exposing people to excess radio frequency radiation. You may contact the manufacturer for further instructions.

Radiation warning



WARNING! Maintain a separation distance of at least 1 m from the front face of the antenna to a person.

You, as the qualified end-user of this radio device, must control the exposure conditions of bystanders to ensure the minimum separation distance (above) is maintained between the antenna and nearby persons, for satisfying RF Exposure compliance. The operation of this transmitter must satisfy the requirements of General Population/ Uncontrolled Environment. Only use the terminal when persons are at least the minimum distance from the front face of the antenna.

About this manual

Intended readers

This manual is a user manual for the EXPLORER 710. The manual is intended for anyone who is using or intends to use the EXPLORER 710. No specific skills are required to operate the EXPLORER 710. However, it is important that you observe all safety requirements listed in the **Safety summary** in the beginning of this manual, and operate the EXPLORER 710 according to the guidelines in this manual.

Related documents

The following documents are related to this manual and to the EXPLORER 710 system.

Title and description	Document number
EXPLORER 710 Getting Started, English	98-139653
EXPLORER 710 Getting Started, Deutsch (German)	98-140216
EXPLORER 710 Getting Started, Français (French)	98-140217
EXPLORER 710 Getting Started, Español (Spanish)	98-140218
EXPLORER 710 Getting Started, Русский (Russian)	98-140219
EXPLORER 710 Getting Started, 中文 (Chinese)	98-140220
EXPLORER 710 Getting Started, 日本語 (Japanese)	98-140221

Typography

In this manual, typography is used as indicated below:

Bold is used for the following purposes:

- To emphasize words.
Example: “Do **not** touch the antenna front during pointing”.
- To indicate what the user should select in the user interface.
Example: “Select **Control panel** > **LAN** and click **Enable**”.

Italic is used to emphasize the paragraph title in cross-references.

Example: “For further information, see *Connecting Cables* on page...”.

Table of Contents

Chapter 1	Introduction to EXPLORER 710	
	General description	1
	Features and interfaces of the EXPLORER 710	2
	Your EXPLORER 710 terminal	4
Chapter 2	To get started	
	To unpack and assemble the EXPLORER 710	8
	Cable connections	14
	To start up the EXPLORER 710	16
	To access the network	17
	To connect to the WLAN interface	20
	To connect to the LAN interface	21
	To connect your phone to the EXPLORER 710	22
	To make the first call or data session	26
	Fixed antenna installation	29
Chapter 3	To use the EXPLORER 710	
	BGAN or cellular network	30
	User interfaces	30
	Data connection with computer, smartphone or tablet	32
	To access the terminal from a remote location (BGAN only)	37
	Phone connection	42
	To charge your smartphone or tablet	46
	To see alerts	46
	Terminal settings in display	46
	To see properties of the EXPLORER 710 in the display	47
	Tracking and location reporting	47
Chapter 4	To use the web interface	
	Configuration with EXPLORER Connect app	49
	The web interface	50

To enter the SIM PIN in the web interface	53
To point the antenna (BGAN)	54
To control data connections from web interface (BGAN)	55
Status information	58
The Control panel	60
To use the logs	61
Battery status information	62
To set up the interfaces	63
To manage connected devices (Traffic control)	66
To manage IP handsets or smartphones	68
Support features	70
Terminal settings	73
To set up your data connection packages	79
To set up tracking and location reporting	88
Advanced LAN	90
Advanced settings	92
Optional: To set up cellular network for data	110
Chapter 5 Maintenance and troubleshooting	
To get support	112
Software update	113
Maintenance	116
Troubleshooting	119
Log files	132
List of reserved IP subnets	133
Appendix A Technical specifications	
General specifications	134
Battery specifications	135
Interfaces specifications	136
Detachable BGAN antenna specifications	141
Satellite coverage	142

Appendix B Command reference

Overview of M2M AT and SMS commands	144
SMS remote commands	145
AT commands	150

Appendix C Conformity

General	160
CE	160
IC	160
FCC	161

Glossary	163
-----------------------	-----

Index	167
--------------------	-----

Introduction to EXPLORER 710

General description

The EXPLORER 710 is a handy portable terminal supporting simultaneous voice and data communication over BGAN. It provides versatility and high speed access with multiple interfaces for countless applications. Just connect your phone, laptop, smartphone or tablet, point the antenna towards the BGAN satellite - and you are online.



The EXPLORER 710 provides access to the highest bandwidth available on the BGAN network. With BGAN HDR (High Data Rate) you get a portfolio of four channel streaming rates including symmetric and asymmetric options so you only pay for the data you need. The system offers multi-user as well as single-user functionality, making it a flexible solution for a variety of applications, such as:

- Broadcasting
- Internet browsing
- E-mail
- Phone services
- Large file transfers
- Video conference and Streaming
- VPN (Virtual Private Network) access to corporate servers

The EXPLORER 710 can withstand severe environmental conditions such as humidity, dust, extreme weather and changing temperatures. It is small in size and fits easily into a backpack or similar. With the detachable antenna it is well suited for temporary camps or fixed installations.

Features and interfaces of the EXPLORER 710

Features

- Full duplex, single or multi-user, standard data up to 492 kbps
- Support for streaming data at 16, 32, 64, 128, 176, 256 kbps, HDR (asymmetric or symmetric) and BGAN X-Stream.
- Support for bonding of two EXPLORER 710 terminals, providing streaming rates over 1 Mbps for UDP traffic.
- Standard LAN w. PoE, WLAN, ISDN and Phone ports and USB Host interface.
- Detachable antenna with integrated transceiver stand and transceiver-to-antenna range up to 100 m/328 ft.
- Support for **EXPLORER Cellular Modem** for connection to cellular network.
- Built-in DHCP/NAT wireless router.
- Solar panel direct interface.
- Support for battery hot swap.
- 10-32 VDC input.
- 100-240 VAC power adapter.
- Support for GPS or GLONASS navigation systems.
- Built-in web interface allowing you to manage your calls and customize the terminal to your specific needs, using a smartphone, computer or tablet.
- Support for the **EXPLORER Connect** smartphone app allowing you to use your phone as a satellite phone and to access the settings of the terminal.
- Advanced network management.
- Dedicated connections (BGAN only)
- Point-to-Point Protocol over Ethernet (PPPoE).
- Built-in PBX and SIP server managing voice communication.
- Remote management and remote access.
- Multilingual user interface (English, French, German, Russian, Spanish, Chinese, Japanese).
- CE, FCC, GMPCS and IC certified

Overview of interfaces

The EXPLORER 710 provides a number of interfaces for connection of various types of computers, phones and other equipment.

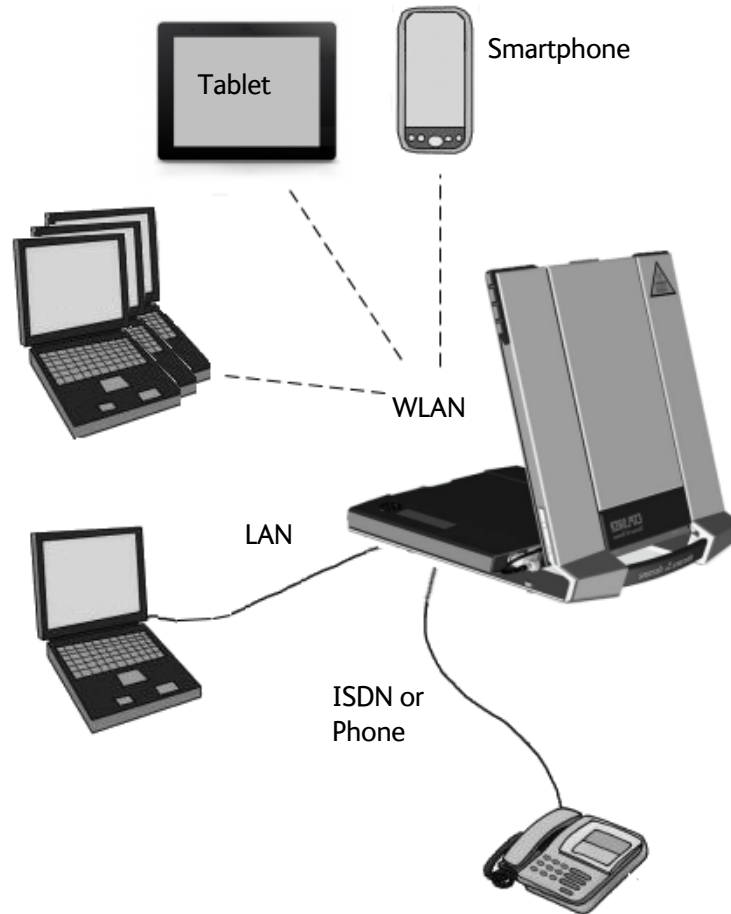

To get started on page 8 describes how to use each of the available interfaces.

To minimize power consumption

The EXPLORER 710 is designed for minimum power consumption. This means that functions that are not currently used will automatically go into a “sleep mode” to minimize the power consumption. In addition to this automatic sleep mode function, you can disable each of the interfaces if they are not currently used. Note, however, that you will not be able to use these interfaces until you enable them again. For information on how to enable/disable interfaces, see *To enable or disable an interface* on page 31.

SIM lock

The supplier may SIM lock the EXPLORER 710 to a specific provider. For further information, contact your supplier.

Your EXPLORER 710 terminal

Overview

The EXPLORER 710 is a compact unit comprising a transceiver with a detachable antenna, compass, display and keypad, all in one unit.

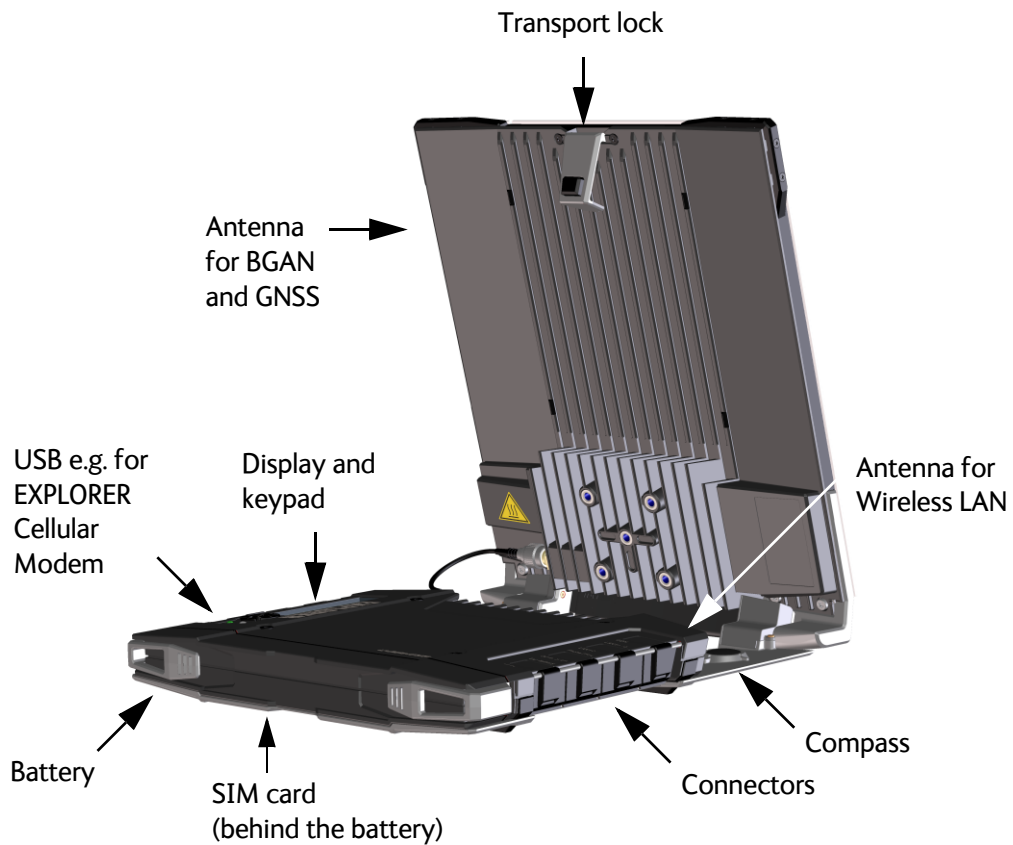

Display and keypad

The EXPLORER 710 has a display and keypad providing quick access to important functions and simple setup, and for displaying status.

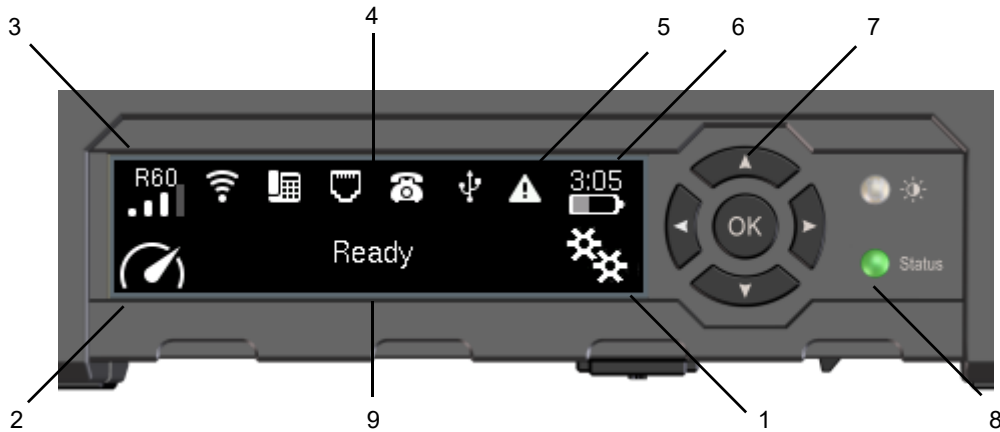

1. Menu: Opens the display menu. For a menu overview, see next page.
2. Connect: Allows you to start a data connection. When a connection package is started, a “1” is added to the icon.
3. Signal strength: Shows the signal strength of the satellite connection and whether the connection is global beam (G), regional beam (R) or narrow beam (N). Press **OK** to see the GNSS position.
4. Interfaces on/off: Allows you to switch the interfaces on or off. Disabled interfaces are crossed out. The WLAN icon shows the number of WLAN-connected devices, if any.
5. Warning: Shows if there are alerts. Press **OK** to see the alerts.
6. Battery status: Shows remaining time for the internal battery and the external battery (if connected).
7. Keypad for navigation: Allows you to move between the available options (arrow keys) and select them (OK).
8. Status indicator: Shows status of the EXPLORER 710. For information on functions, see *Status indicator* on page 125.
9. Status text: Shows the current status of the EXPLORER 710 and the network connection. For example, the text may show the status during start-up (see *The registration procedure (BGAN)* on page 19).

To navigate the display functions

- To **highlight** one of the icons, use the **arrow buttons**.
- To **move around** between the icons, use the **arrow buttons**.
- To **select** menu items, functions or values, press the **OK** key.

Display menu

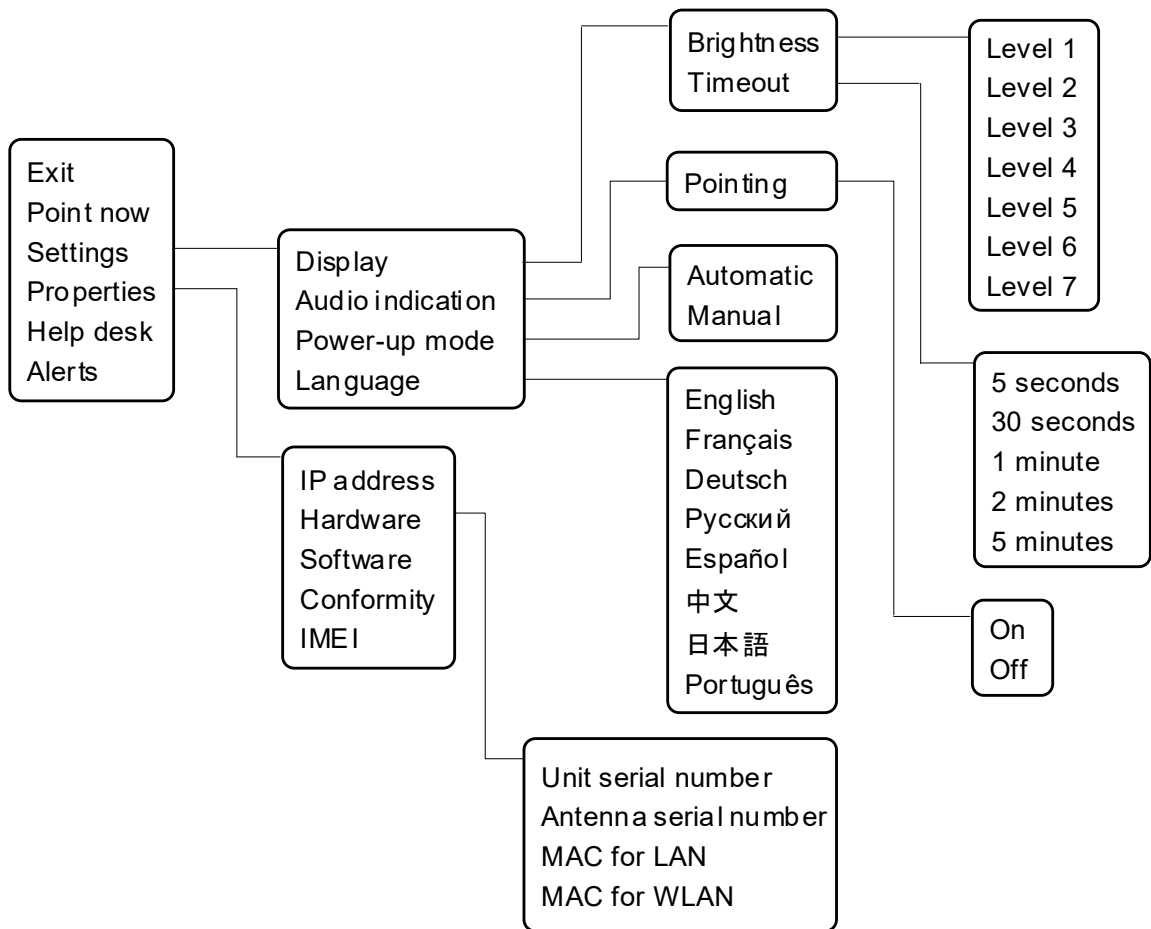

User interfaces

The **keypad and display** described in the previous section are used for pointing the antenna, starting and stopping data sessions, enabling or disabling interfaces and for displaying status and changing simple parameters. To obtain full access to all features and for ease-of-use, you should use a computer or smartphone and the web interface.

The **web interface** is a built-in web interface for easy configuration and daily use. The web interface is accessed from a computer, smartphone or tablet connected to the EXPLORER 710, using an Internet browser. No installation of software is needed. For further information on the web interface, see *To use the web interface* on page 48.

A **smartphone app, EXPLORER Connect**, is also available. The app includes a satellite phone function that enables you to make calls to and from your smartphone over the satellite network using the EXPLORER 710 terminal. It also includes the complete feature set from the built-in web interface of the terminal, allowing you to set up and use the terminal with your smartphone. See *The EXPLORER Connect app* on page 9.

With **AT commands** you can configure and control the EXPLORER 710 from a computer using a Telnet session. For details see *To access the terminal using AT commands* on page 37.

With **SMS commands** you can configure and control the EXPLORER 710 remotely. For details, see *Remote access with SMS* on page 37.

Antenna

The white part of the EXPLORER 710, including the support bracket, is the detachable antenna module. The antenna module comprises a GNSS (Global Navigation Satellite System) antenna and a BGAN antenna.

A Wireless LAN antenna is located on the transceiver unit.

Compass

The EXPLORER 710 also provides a compass to help positioning the antenna. For further information on how to use the compass, see *To point the antenna (BGAN)* on page 17.

Battery

The EXPLORER 710 comes with a rechargeable battery, which is easily inserted. The battery is automatically recharged when power is applied to the EXPLORER 710. The Status indicator shows that the battery is charging. See *Status indicator* on page 125.

Time between recharging depends on the use. The display shows estimated time left for the battery.

SIM card

The EXPLORER 710 requires a SIM card to go online. Without a SIM card you can still configure the terminal and you may be able to make emergency calls if the network allows it, but you cannot make normal calls nor access the Internet.

SIM lock: The supplier may have locked the SIM card to a specific provider. For further information, contact your supplier.

To get started

This chapter describes:

- *To unpack and assemble the EXPLORER 710*
- *Cable connections*
- *To start up the EXPLORER 710*
- *To connect to the WLAN interface*
- *To connect to the LAN interface*
- *To connect your phone to the EXPLORER 710*
- *To make the first call or data session*
- *Fixed antenna installation*

To unpack and assemble the EXPLORER 710

Initial inspection

Inspect the shipping carton immediately upon receipt for evidence of damage during transport. If the shipping carton is severely damaged or water stained, request that the carrier's agent be present when opening the carton. Save the carton packing material for future use.



WARNING! To avoid electric shock, do not apply power to the system if there is any sign of shipping damage to any part of the front or rear panel or the outer cover. Read the safety summary at the front of this manual before installing or operating the system.

After unpacking the system, inspect it thoroughly for hidden damage and loose components or fittings. If the contents are incomplete, if there is mechanical damage or defect, or if the system does not work properly, notify your dealer.

What's in the delivery

The following items are included in the delivery:

- EXPLORER 710 terminal including transceiver, antenna and antenna cable
- Battery pack
- AC/DC adapter
- Getting started kit including:
 - Ethernet/ISDN cable, 2 m screened
 - Getting started booklet

The EXPLORER Connect app

If you want to use your smartphone with the EXPLORER 710, install the **EXPLORER Connect** app, which is available for iPhone at the App Store and for Android phones at Google Play. The EXPLORER Connect app provides the following options from the main menu:

Tile	Function
Satellite Phone	Use your phone as a satellite phone when connected to the EXPLORER 710, see <i>To connect your smartphone for making calls</i> on page 22.
Terminal Access	Start and stop data connections and access all settings of the EXPLORER 710
Pointing	Activate the pointing process for the EXPLORER 710 towards the BGAN satellite, see <i>Pointing in EXPLORER Connect app</i> on page 19.
Dashboard	See the terminal and connection status

To check the version of the EXPLORER Connect app

Check the version of your EXPLORER Connect app as follows (minimum IOS app ver 1.1/ Android app ver 1.9):

IOS:

1. On your iPhone or iPad select **Settings** (Iphone settings, **not** settings in EXPLORER Connect app).
2. Scroll down to **EXPL connect**.
3. Select **EXPL connect**.
The version is shown.

Android:

1. In the **EXPLORER Connect** app, from the main menu, select  (Settings) in the bottom right corner.
2. Scroll down to **Version**.

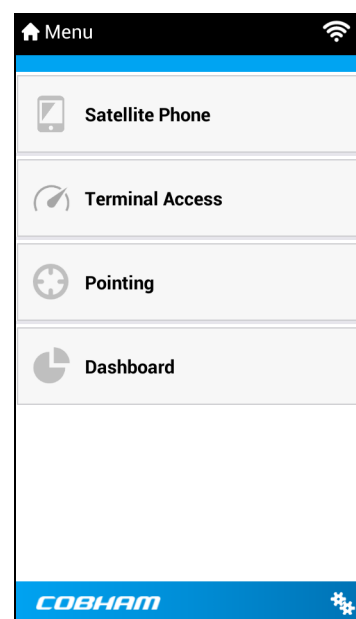

To open the transport latch

The EXPLORER 710 has a transport latch, securing the transceiver and antenna during transport.

1. Lift the transport latch to open the terminal.

Note The transport latch closes tightly in order not to open by accident. If the latch is difficult to open, press the two parts of the terminal together while opening the latch.

2. Flip up the antenna module.
You can now access the keypad and connectors on the EXPLORER 710.

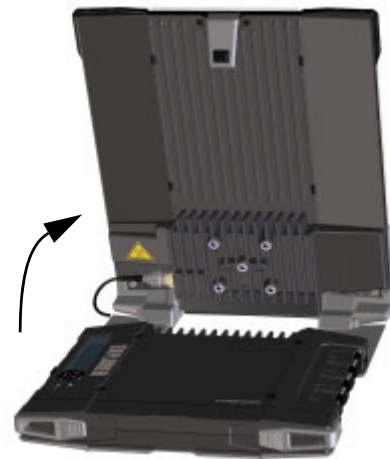
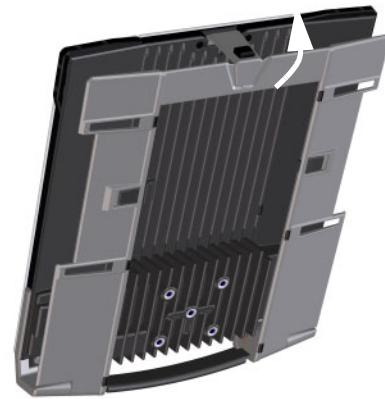

To detach the antenna (optional)

You have two options for using the EXPLORER 710 antenna:

- **Attached.** You can go through the pointing process with the antenna and transceiver attached as one unit. This means you have to move the entire terminal in order to point the antenna towards the BGAN satellite. If you choose this option, make sure you connect all cables including the short antenna cable, and enter the PIN, before pointing the antenna. If not, you may accidentally move the antenna when you connect cables or enter the PIN.
- **Detached.** You can detach the antenna module and use it as a separate antenna. With the antenna separated from the transceiver, it is easier to use the transceiver without accidentally moving the antenna. Also, you can choose the optimum location for the antenna while keeping the transceiver in a more comfortable location.

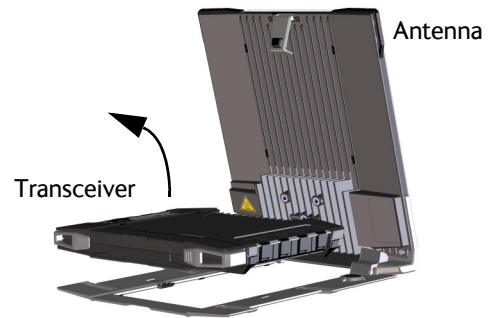

Important

Do **not** place the transceiver in front of the antenna module!
The antenna emits radio frequency energy, which can affect the transceiver.

To detach the antenna, do as follows:

1. Locate the slide locks on the bottom of the terminal.
2. Press and slide the locks outwards while lifting the transceiver to release it from the antenna bracket.



3. Remove the transceiver from the antenna bracket.

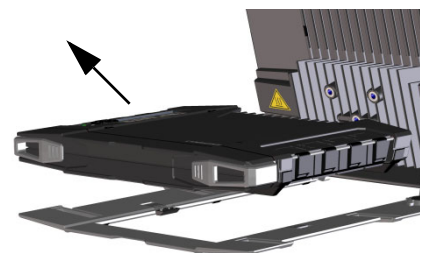

4. To move the antenna and transceiver further apart, disconnect the short antenna cable and connect a longer antenna cable between the antenna and the transceiver.

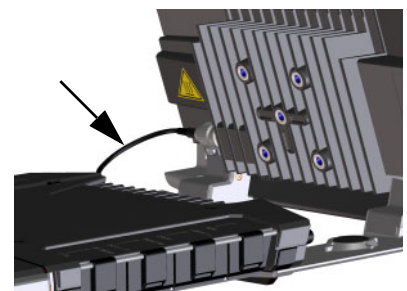

To insert the SIM card

The SIM card is provided by your Airtime Provider. Insert the SIM card as follows:

1. Locate the SIM slot on the same side where the battery is inserted.
2. Insert the SIM card into the SIM slot with the chip side facing up.
3. Press gently until it clicks.
4. Slide the lock in front of the SIM slot.



To insert the battery

Note The battery should not be partially charged too often. For further information on the battery, see *Maintenance* on page 116.

Do as follows:

1. Insert the battery so that the connector fits into the battery slot, indicated in the figure.
2. Press gently until it locks.



Note Before using the terminal the first time: to ensure accurate information on the battery capacity you should fully charge, then fully discharge the battery, and finally recharge the battery while it is inserted in the terminal. The EXPLORER 710 can be used during the discharging process, but the remaining battery capacity may not be displayed correctly.

For information on how to recharge the battery, see *To recharge batteries* on page 116.

To remove the battery

Note For protection of the transceiver, always leave the battery inserted. Only remove the battery to replace it.

To remove the battery, do as follows:

1. If the transceiver and antenna are attached, open the transport latch and detach the antenna as described in *To detach the antenna (optional)* on page 11.
2. On the transceiver, open the battery latches as shown.
3. Remove the battery.

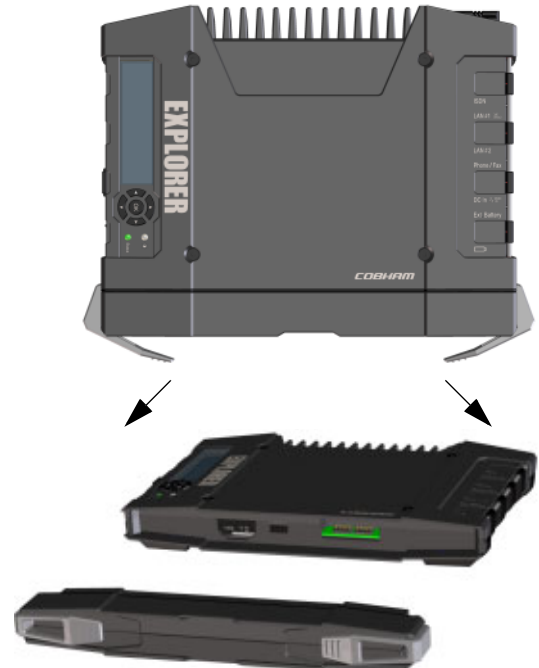

To remove the SIM card

To remove the SIM card, first remove the battery as described in *To remove the battery* in the previous section.

Note When the SIM card is removed you cannot make calls or data sessions, but you can still use the display menu system and the built-in web interface to set up the terminal.

Remove the SIM card as follows:

1. Slide the lock aside to open the SIM slot as shown.
2. Gently press the SIM card and let it pop out of the slot.
3. Remove the SIM card.

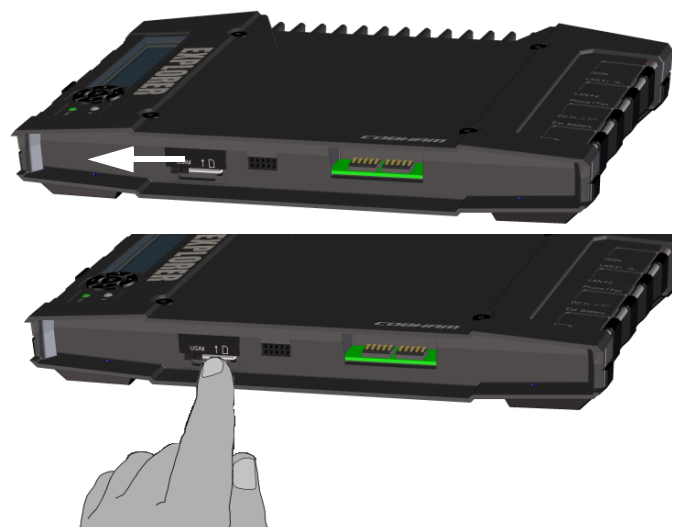

Cable connections

Connectors

The connector panel is placed on the side of the EXPLORER 710 and has the following connectors:

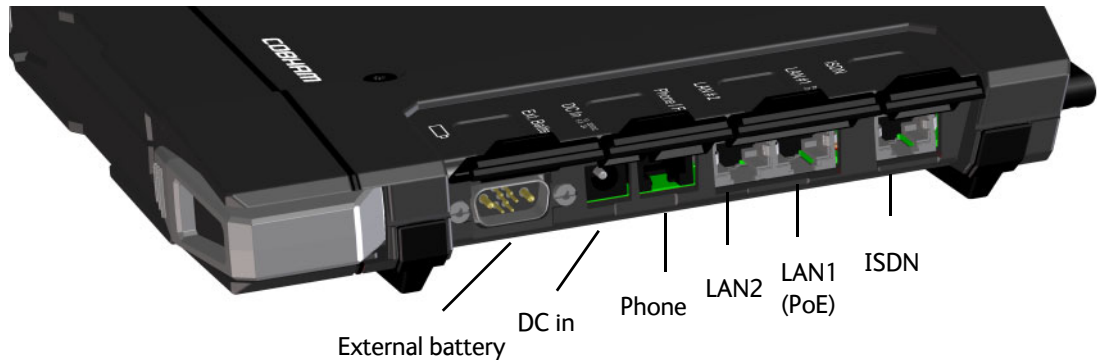

- 1 **Ext battery** connector for connecting an **extra EXPLORER 710 battery**.
See *To connect an extra, external EXPLORER 710 battery* on page 117.



CAUTION! Close the cover for this connector when not in use! If you accidentally connect the DC power cable to this connector you may cause damage to the terminal.

- 1 **DC power input** connector for 10 - 32 VDC.
See *To connect power* on page 15.
- 1 **Phone** connector.
See *To connect an analog phone* on page 24.
- 2 **LAN** connectors, one with **PoE**.
See *To connect to the LAN interface* on page 21 and
To connect a phone using LAN or WLAN on page 22.
- 1 **ISDN** connector.
See *To connect an ISDN phone or modem* on page 25.

Apart from the connectors in the connector panel, there is:

- 1 **USB (Host)** connector placed next to the Power button.
The USB (Host) connector is used for the following purposes:
 - Charge phones or tablets (up to 2 A).
See *To charge your smartphone or tablet* on page 46.
 - Recovery update of software.
See *To update software with USB* on page 114.

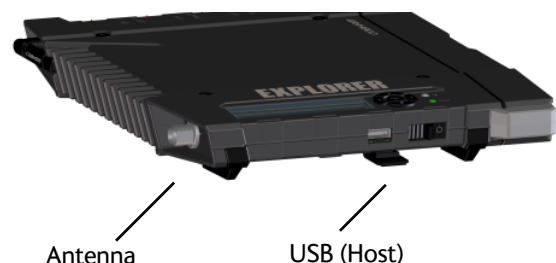

- Connect an EXPLORER Cellular Modem to obtain a cellular network connection as an alternative to the BGAN network.
See *Optional: To set up cellular network for data* on page 110.
- 1 **antenna** connector for connecting the antenna module of the EXPLORER 710.
See the next section.

To connect the antenna

The antenna cable is connected at delivery.

Note

If you want to use the antenna separated from the transceiver, use a longer antenna cable and remove the transceiver from the antenna bracket. See the *To detach the antenna (optional)* on page 11.

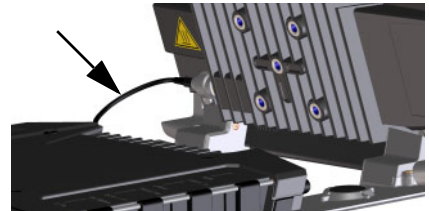

To connect power

When you connect external power to the DC input, the battery is charged while maintaining normal operation.

DC input

Refer to *Technical specifications* on page 134 for specifications and pin-out for the DC Power input.



CAUTION! Close all covers for unoccupied connectors as shown in the picture below. Reason: If you accidentally connect the DC power cable to the External battery connector you may cause damage to the terminal!

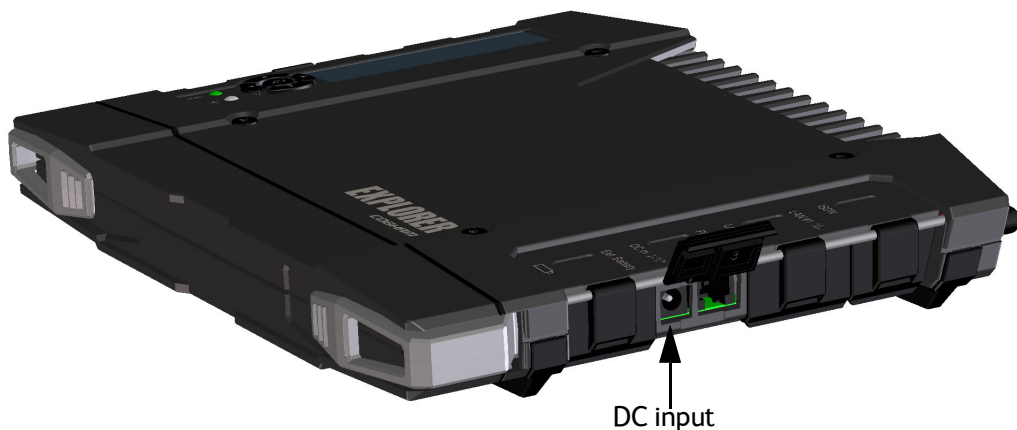

To power the terminal or to charge the battery, connect one of the following external power sources to the DC input:

- 10-32 VDC
- The supplied AC/DC adapter connected to 100-240 V Mains
- A solar panel (min. 65 W, 10-32 VDC)

To start up the EXPLORER 710

Automatic power up

The default behavior of the EXPLORER 710 is to power up automatically when you connect external power. If you wish, you can change this power up mode, so that the EXPLORER 710 is only powered if the Power button is pressed.

For further information on power up mode, see *Automatic power up* on page 46.

To switch the EXPLORER 710 on or off

1. Slide and hold the power button until the **Status** indicator lights up. This may take some seconds.
2. When the **Status** indicator flashes slowly or is constant green, and the display shows **Ready**, the terminal is ready for use.
3. To switch off, hold the power button until the **Status** indicator flashes yellow. This may take some seconds.



To enter the SIM PIN

Note

You may not need a SIM PIN for your terminal. If you are asked for a PIN and you select **Cancel**, you cannot communicate on the network, but you can access all terminal settings.

To enter the SIM PIN using the display and keypad, do as follows:

1. When the display shows **Enter PIN?**, highlight the text using the arrow keys and press **OK**. If you select **Cancel**, the startup procedure is continued, but you will not be able to make calls or data sessions over the satellite network. See the previous section.
2. Press ▼ or ▲ a number of times until the first digit is correct.
3. Press **OK** to go to the next digit. The previous digit is indicated by a *.
4. After pressing **OK** to enter the last digit, press **OK** again to apply the PIN.



For an overview of the display and keypad, see *Display and keypad* on page 5.

For information on how to enter the PIN in the web interface, see *To enter the SIM PIN* on page 53.

To access the network

BGAN or cellular network

The EXPLORER 710 is a BGAN terminal. However, you have the option of connecting an EXPLORER Cellular Modem to the USB interface of the EXPLORER 710, making it possible to use the cellular network when it is available. See *Optional: To set up cellular network for data* on page 110.

If you are going to use the BGAN network, you must first point the antenna in the direction of the satellite and find the best possible signal strength. See the next sections for details.

To point the antenna (BGAN)

Note You can choose to cancel pointing. In this case you cannot communicate on the BGAN network, but you can access all terminal settings.

Before pointing

Before pointing the antenna you can use the coverage map below to find your approximate location in relation to the satellites. Then you can use the compass to find the pointing direction to the closest satellite.

The Inmarsat BGAN services are based on the BGAN I4 geostationary satellites and the Alphasat satellite. The map below shows the coverage area.

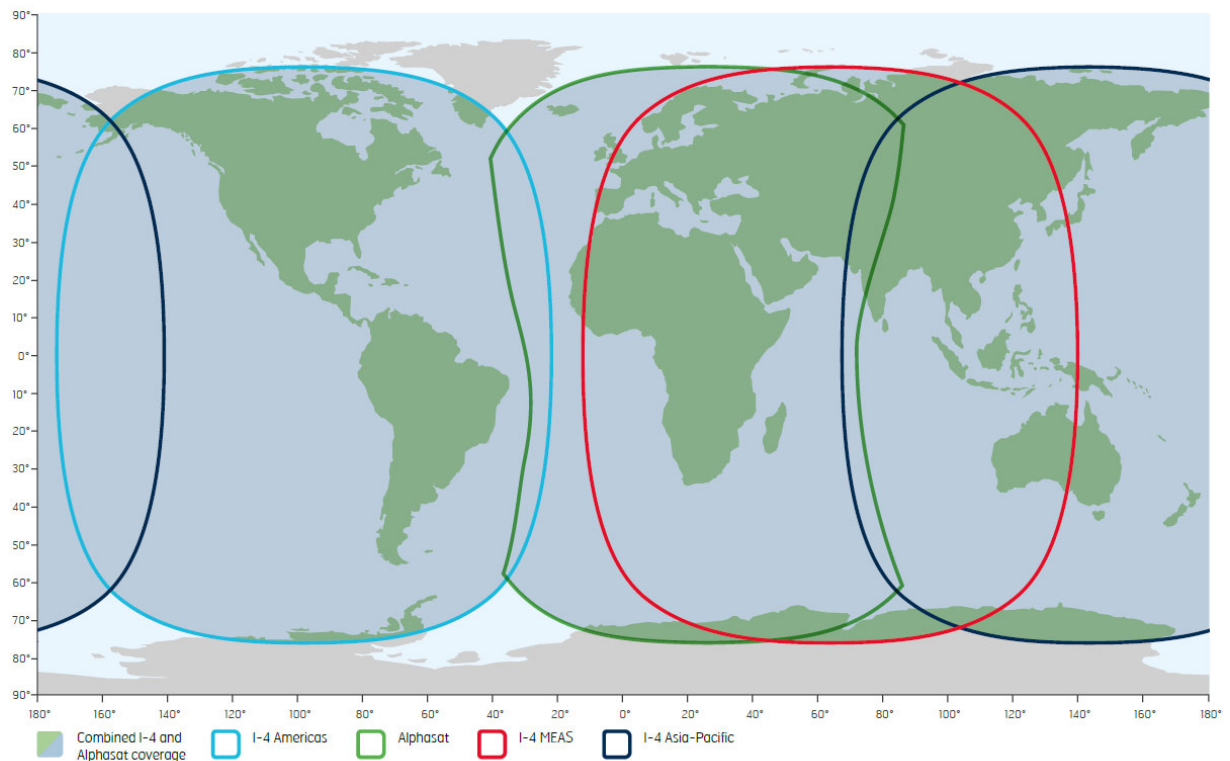

To point the antenna

To obtain optimum bandwidth and operating time, adjust the position of the antenna with great precision.

Do as follows:

1. If the terminal is not already in pointing mode, select  in the display and select **Point now**.
2. Use the compass to locate the approximate direction from the antenna front face to the satellite.
3. Slowly rotate and tilt the EXPLORER 710 antenna to find the highest possible signal strength.

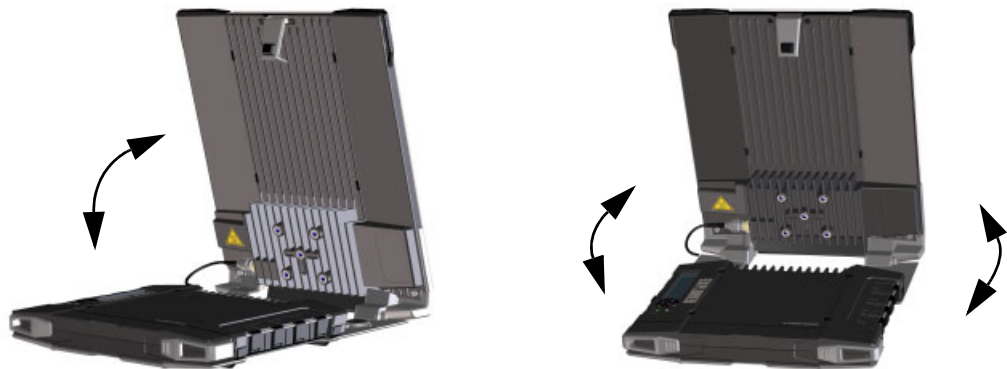
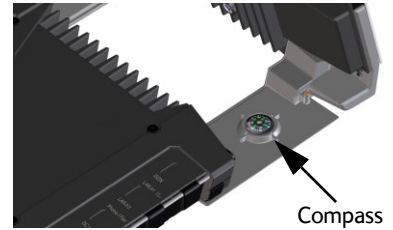

Use the display and the pointing sound to guide you. Remember that the more accurately the terminal is aligned, the better throughput and lower power consumption you will get! You may also use the EXPLORER Connect app, see *Pointing in EXPLORER Connect app* on page 19, or the web interface, see *To point the antenna (BGAN)* on page 54.

4. Press **OK** on the display keypad when you have obtained the highest possible signal strength.

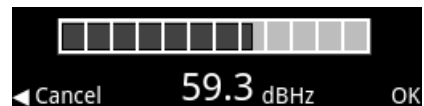

The EXPLORER 710 now starts to establish a connection to the BGAN network.



CAUTION! After accepting the signal strength, keep the minimum safety distance of **1 m from the antenna front face**. The antenna may radiate microwave power as soon as the signal strength is accepted.

Audio assisted pointing

You can set up whether or not you want a sound to indicate the signal level during pointing (Audio assisted pointing), to help you find the maximum obtainable signal strength. The sound pattern is as follows:

- Poor signal strength: • • • •
- Good signal strength: ••••••••••••••••••••
- Optimum signal strength: **████████████████████** (continuous sound instead of single “beeps”)

To enable or disable the pointing sound:

1. Select  in the display.
2. Select **Settings > Audio indication > pointing**.
3. Select **On** or **Off**.

The registration procedure (BGAN)

The display shows the progress as follows:

- **Searching:**
The EXPLORER 710 searches for the network operator. Note that the search procedure can be very short, so you may not see this text.
- **Registering:**
The EXPLORER 710 is registering itself on the network.
If the GNSS position has not yet been acquired at this point, the display may show **No position**.
- **Ready** (or other status information):
Ready means the EXPLORER 710 is registered on the network and is ready to go online. If there is any other status information to show, e.g. if a call or data session is active or there is a warning, the display will show that instead.

Note

By default, if you want to use a data connection, you must manually start it from the display or from the web interface. See *To make the first call or data session* on page 26. However, you can set up the EXPLORER 710 to automatically connect to the Internet when you connect equipment to the LAN or WLAN interface. See *Automatic Context Activation (ACA)*.

To repoint the antenna

You may need to point the antenna again later, e.g. if the terminal has been moved or the signal is blocked.

To start the pointing process again, do as follows:

Display: Select  and select **Point now**. Then go through the pointing process as described in the previous section, and press **OK** in the keypad when the signal strength is OK.

web interface: Select  (Control panel) > **Point now**. Then go through the pointing process as described in the previous section and click **Accept** in the web interface or **OK** in the display.

Pointing in EXPLORER Connect app

To start the pointing procedure from the EXPLORER Connect app, do as follows:

1. Select **Pointing** from the EXPLORER Connect app.
2. If the pointing process is not already started, tap **Start**.
The signal strength is shown on the screen.

3. Turn and tilt the antenna slowly as described in the previous sections until you have obtained the highest possible signal strength.
4. Tap **Accept**. The terminal will now try to register on the BGAN network.

To connect to the WLAN interface

To connect to the WLAN interface, do as follows:

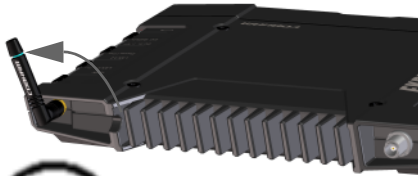
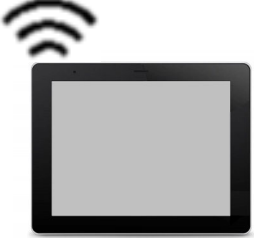
1. Check that WLAN is enabled in your EXPLORER 710. The top line of the display shows which interfaces are enabled. 
2. If your device is not close to the EXPLORER 710, turn the WLAN antenna of the transceiver into an upright position. 
3. Place your WLAN-enabled device (computer, tablet or smartphone) close to the EXPLORER 710, but **not** in front of the antenna. 
4. On your device, search for available WLAN networks.
5. Select the EXPLORER 710 WLAN access point when it appears in your list of available wireless networks. The default name is **EXPLORER710**.
6. You may have to enter a password.
By default, the password is the **serial number** of your EXPLORER 710 and the encoding type is **WPA2**. You can find the serial number in the display menu under **Properties > Hardware > Unit serial number**.

Important

Remember to change the password (Encryption key) after first connection! See *WLAN interface setup* on page 63.

Note

The EXPLORER 710 supports maximum 10 units connected to the WLAN interface.

Your device should now be connected to the EXPLORER 710. The WLAN icon in the display and in the web interface shows the number of WLAN-connected devices (example: ). If you want to connect to the Internet, you must start a data connection, see *To start or stop a data connection using the display* on page 28. The status text in the display shows when there is an active data connection.

You are now ready to browse the Internet, check e-mails, send files etc.

Calls: If you want to use WLAN to make calls over the BGAN network, you must have a SIP client installed on your smartphone. See *To connect a phone using LAN or WLAN* on page 22.

For information on how to configure the WLAN interface, see *WLAN interface setup* on page 63.

To connect to the LAN interface

Before connecting to the LAN interface

The EXPLORER 710 has two LAN connectors. If more than one LAN or WLAN user is connected to the EXPLORER 710, the terminal should be in Router mode (default). Refer to *To set up the connection mode* on page 74.

To connect to the LAN interface, use a shielded cable mounted with an RJ-45 connector.

For specifications, refer to *LAN interface* on page 139.

For the LAN interface to work without any further setup, the computer must be set up to obtain an IP address and a DNS server address automatically.

To connect to the LAN interface

This section does not describe configuration of the LAN interface. For information on configuration, see *LAN interface setup* on page 63.

To connect to the LAN interface, do as follows:

1. Connect the LAN cable to the network interface of your computer.
A suitable cable is provided with your EXPLORER 710.
2. Connect the other end of the cable to one of the LAN connectors on the EXPLORER 710.

Important

The ISDN interface and the LAN interface use the same connector type. Be careful not to connect to the wrong interface.



Your computer should now be connected to the EXPLORER 710. If you want to connect to the Internet, you must start a data connection, see *To start or stop a data connection using the display* on page 28. The status text in the display shows when there is an active data connection.

To connect your phone to the EXPLORER 710

To connect a phone using LAN or WLAN

Your smartphone or IP phone can be set up to make and receive calls over the BGAN network, using the terminal's phone number. You can also make local calls to other handsets connected to the EXPLORER 710.

Note

Make sure your phone has an integrated SIP client. Cobham SATCOM offers the **EXPLORER Connect** app with a built-in SIP client that is ready to use with the EXPLORER 710. You can also find other SIP applications on the Internet.

To connect your smartphone for making calls

To use your phone to make calls through the EXPLORER 710 using WLAN, do as follows:

1. Start up the EXPLORER 710 terminal.
2. Connect your smartphone to the wireless access point of the EXPLORER 710.
See *To connect to the WLAN interface* on page 20.
3. Start the **EXPLORER Connect** app and select **Satellite Phone** (or start another SIP application). If it is the first time you use the EXPLORER Connect app, you must select **Register** when prompted.



Note

If you are using the EXPLORER Connect app for the first time, make sure that “Enable Reception of Incoming Calls” is selected in the settings page. This is to prevent your smartphone from closing the WLAN connection when not in use. This is necessary in order to be able to receive calls on your smartphone.

You should now be ready to make and receive calls over BGAN. For details on **initial setup** of your smartphone and the EXPLORER 710, see

- The documentation for your handset
- *First time SIP setup* on page 23
- *To manage IP handsets or smartphones* on page 68

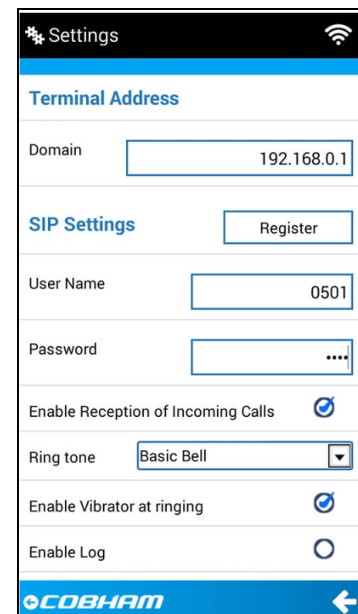

To connect a wired IP handset for making calls

Note Make sure your IP handset complies with PoE class 2 (7 W).

Note If you are using a Thrane IP Handset and have enabled support for it, no initial configuration is necessary.

For details on **initial setup** of your IP handset and the EXPLORER 710, see

- The documentation for your handset
- *First time SIP setup* on page 23
- *To manage IP handsets or smartphones* on page 68

To connect a wired IP handset, do as follows:

1. Start up the EXPLORER 710 terminal.

Note Make sure PoE is enabled in the terminal. See *LAN interface setup* on page 63.

2. Connect the LAN cable between the IP handset and the connector **LAN #1** on the EXPLORER 710.

When the IP handset is powered and ready, you should now be able to make and receive calls over BGAN.

First time SIP setup

If you do not have a Thrane IP Handset nor a phone with the EXPLORER Connect app and it is the first time you connect your phone to the LAN or WLAN interface for making calls, you must first set up the SIP server details in your smartphone. For information how, see the user documentation for your smartphone and for the SIP application. You may be asked to enter some of the following details:

- SIP server address and port: Default address: 192.168.0.1, Port: 5060
- User name: Local no. in EXPLORER 710 (0501 to 0516)
- Password: Default same as user name
- Codec priority: Highest priority codec type: G.711

Note The user name and password must match the IP handset settings in the web interface of the EXPLORER 710. See *To manage IP handsets or smartphones* on page 68.

To connect an analog phone

Before connecting to the Phone interface

To connect a phone to the Phone connector, you need an analog telephone cable with an RJ-11 connector. For specifications and pin-out, refer to *Phone interface* on page 137.

To connect to the Phone interface

Do as follows:

1. Connect the cable to your phone.
2. Connect the other end of the cable to the Phone connector on the EXPLORER 710.

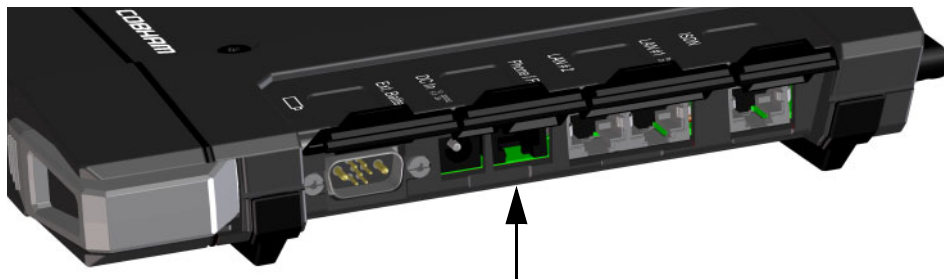

3. Power up the EXPLORER 710 and point the antenna as described in *To point the antenna (BGAN)* on page 17.
4. Check the connection by making a phone call.
See *To make or receive a phone call with EXPLORER 710* on page 42.

If connection fails, check that the interface is enabled in the EXPLORER 710. If the analog phone icon is crossed out in the display main screen, the interface is disabled. See *To enable or disable an interface* on page 31.

To connect an ISDN phone or modem

Before connecting to the ISDN interface

To connect a phone or modem to the ISDN connector, you need an ISDN cable with an ISDN connector. For specifications and pin-out, refer to *ISDN interface* on page 138.

To connect to the ISDN interface

The ISDN interface supports connection of up to 4 devices. However, if you are going to connect more than one device, the devices must be self-powered. The ISDN interface can supply maximum 1 W.

The BGAN Core network presently only supports one 64 kbps ISDN channel per subscription.

Do as follows:

1. Connect the ISDN cable to your phone or modem.
2. Connect the other end of the cable to the ISDN connector on the EXPLORER 710.



3. Power up the EXPLORER 710 and point the antenna as described in *To point the antenna (BGAN)* on page 17.
4. Check the connection by making a phone call.
See *To make or receive a phone call with EXPLORER 710* on page 42.

If connection fails, check that the ISDN interface is enabled in the EXPLORER 710.

If the ISDN icon is crossed out in the display main screen, the interface is disabled. See *To enable or disable an interface* on page 31.

To make the first call or data session

To make the first call

After entering the PIN, pointing the antenna and connecting your equipment, you are ready to make or receive the first call. The following sections provide a short guide to making calls. For more detailed information, see *To make or receive a phone call with EXPLORER 710* on page 42.

For details on how to connect your phone, see

- *To connect a phone using LAN or WLAN* on page 22
- *To connect an analog phone* on page 24
- *To connect an ISDN phone or modem* on page 25

To make a call from the EXPLORER 710

To make a call from a phone connected to the EXPLORER 710, dial

00 <country code> <phone number> followed by # or off-hook key.

Example: To call Cobham SATCOM in Denmark (+45 39558800) from an analog phone, dial **00 45 39558800 #**

To make a call to the EXPLORER 710

To make a call to a phone connected to the EXPLORER 710, dial

+ <Mobile number>

- + is the prefix used in front of the country code for international calls.
- Mobile number: The mobile number of the EXPLORER 710 you are calling. The first part of the mobile number is always 870, which is the “country code” for the BGAN system. For information on your mobile numbers, refer to your airtime subscription.

Note | There are two voice numbers, one for 3.1 kHz audio and one for Standard voice.

Example: If you are calling from Denmark and the mobile number for 3.1 kHz audio is 870782112345 on your EXPLORER 710, and you want to make a call to the EXPLORER 710 using 3.1 kHz audio, dial **00 870 782112345**.

To make the first data connection (LAN)

Note For the LAN interface to work without any further setup, your computer must be set up to obtain an IP address and DNS server address automatically.

Do as follows:

1. Connect a LAN cable between your computer and LAN#1 or LAN#2 on the EXPLORER 710.
2. When power up and pointing is completed, you can start a Standard data connection from the display or from the web interface. See *To start or stop a data connection using the display* on page 28.

The status text in the display shows the active connection.

To make the first data connection (WLAN)

To connect to the WLAN interface, do as follows:

1. Check that WLAN is enabled in your EXPLORER 710. The top line of the display shows which interfaces are enabled. If WLAN is disabled, use the keypad arrows to highlight the WLAN icon and OK to enable WLAN.
2. If your device is not close to the terminal, turn the WLAN antenna of the transceiver into an upright position.
3. Place your WLAN-enabled device (computer, tablet or smartphone) close to the EXPLORER 710, but **not** in front of the antenna.
4. On your device, search for available WLAN networks.
5. Select the EXPLORER 710 WLAN access point when it appears in your list of available wireless networks. The default name is **EXPLORER710**.
6. If you are prompted, enter the password. By default, the password is the **serial number** of your EXPLORER 710 and the encoding type is **WPA2**. You can find the serial number in the display menu under **Properties > Hardware > Unit serial number**.
7. When your device shows that it is connected to the EXPLORER 710, you can start a data connection as described in the next section.



For information on how to configure the WLAN interface, see *WLAN interface setup* on page 63.

To start or stop a data connection using the display

By default, you must manually start data connections. However, for some types of connection you can enable Automatic Context Activation in the web interface. See *Automatic Context Activation (ACA)* on page 81.

To start a data connection

Do as follows:

1. Start up the terminal as described in *To start up the EXPLORER 710* on page 16.
2. Connect your equipment to the interface you want to use.
3. Use the arrow keys to highlight the connection icon in the bottom left corner of the display.



4. Push **OK** to see the available connection packages.
5. Go to the connection package you want to start or stop.
6. Push **OK** on the keypad.
7. Push **OK** again to start the connection.

Note It may take some time to start up the connection. The display shows the status while the connection is being established and the number on the connection icon changes from 0 to 1 when the connection package is up and running. If the connection fails, the display shows an error message.

You should now be able to access the Internet from you connected device.

To stop a data connection

Do as follows:

8. Use the arrow keys to highlight the connection icon in the bottom left corner of the display.
9. Push **OK**. The running connection is displayed with **Stop** highlighted.
10. Push **OK** on **Stop** to stop the connection.

For information on how to start and stop data connections with the web interface, see *To control data connections from web interface (BGAN)* on page 55.

For information on how to configure the data connections, see *To set up your data connection packages* on page 79.

Fixed antenna installation

You can keep the EXPLORER 710 antenna in a fixed position, using the Pole mount kit for EXPLORER 710.

Do as follows:

1. Separate the antenna from the transceiver as described in *To detach the antenna (optional)* on page 11.
2. Mount the EXPLORER 710 antenna on a pole or a wall, for example using the Pole mount kit.



CAUTION! The bolt or thumb screw must penetrate **maximum 9 mm** into the thread in the EXPLORER 710

3. Connect the antenna cable between the antenna and the transceiver.
4. Start up the EXPLORER 710 and point the antenna as described in *To point the antenna (BGAN)* on page 17.
5. Accept the signal strength by pressing **OK** on the EXPLORER 710 keypad.
6. Fasten the EXPLORER 710 antenna in the pointed position.

You only have to point the antenna once, when you mount it. Using a computer connected to the EXPLORER 710, you can set up the EXPLORER 710 to skip pointing at power up. Refer to *Pointing at start-up* on page 74.

To use the EXPLORER 710

This chapter describes daily use and basic setup using the display. For information on the web interface, see *To use the web interface* on page 48.

This chapter describes:

- *BGAN or cellular network*
- *User interfaces*
- *Data connection with computer, smartphone or tablet*
- *Phone connection*
- *To see alerts*
- *Terminal settings in display*
- *To see properties of the EXPLORER 710 in the display*
- *Tracking and location reporting*

BGAN or cellular network

The EXPLORER 710 is a BGAN terminal. However, you have the option of connecting an EXPLORER Cellular Modem to the USB interface of the EXPLORER 710, making it possible to use the cellular network when it is available. See *Optional: To set up cellular network for data* on page 110.

User interfaces

The following user interfaces are available when using the EXPLORER 710

- Phone
- ISDN
- LAN
- WLAN
- USB (Host)

To enable or disable an interface

To enable or disable interfaces with the display and keypad

Note | By default, only the LAN interface is enabled. However, you can enable or disable each of the interfaces independently.

To enable or disable an interface, do as follows:

1. In the top of the display, locate the interface you want to enable or disable.

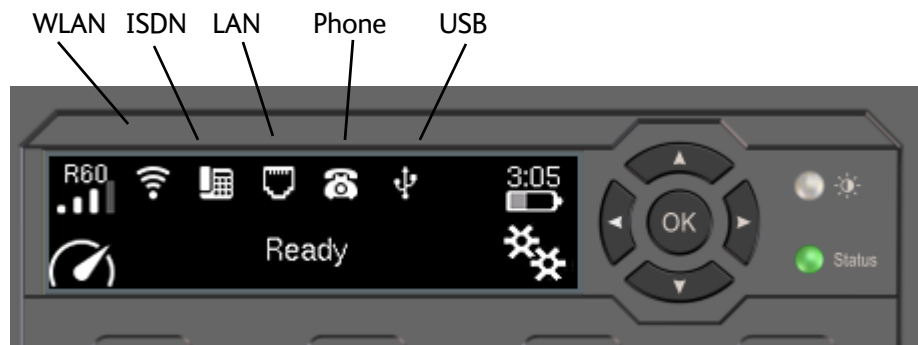

2. Use the arrow keys on the keypad to highlight the interface you want to enable or disable.
3. Press **OK** to toggle between enable and disable. The interface is grayed and crossed out when disabled.



Note | It may take some seconds to enable an interface. When the icon stops pulsating and is no longer crossed out, the interface is enabled.
If you cannot enable/disable an interface, it may be because the User permissions do not allow it. See *To set up user permissions* on page 93.

To enable or disable interfaces with the web interface

Note | By default, only the LAN interface is enabled. However, you can enable or disable each of the interfaces independently.

To enable or disable an interface using the web interface, do as follows:

1. Connect your smartphone, tablet or computer to the EXPLORER 710, using the LAN or WLAN interface. See:
 - *To connect to the LAN interface* on page 21
 - *To connect to the WLAN interface* on page 20
2. To access the web interface, open your browser and type the IP address of your EXPLORER 710¹ (default IP address: 192.168.0.1).
For further information on the web interface, see *To use the web interface* on page 48.

1. You find the IP address in the display menu system by entering the menu and selecting **Properties > IP address**.

3. When the web interface opens, click  (Control panel) from the bottom right corner of the page.
4. Locate the icon with the interface you want to enable or disable.
 - If the icon is gray with a line across, the interface is **disabled**.
 - If the icon is blue, the interface is **enabled**.
5. To enable or disable the interface, click the icon for the interface and select or clear **Enable**.
6. Click **Save**.

Note

It may take some seconds to enable the interface. When the icon changes to the **enabled** (blue) icon, the interface is enabled.

Data connection with computer, smartphone or tablet

Overview

The following interfaces are available for connecting computers, smartphones or tablets:

- WLAN
- LAN

To choose an interface for data connection

The following table shows some characteristics of each interface to help you choose the right interface for your application. For information on how to connect your equipment, see *To connect to the WLAN interface* on page 20 and *To connect to the LAN interface* on page 21.

Interface	Power consumption	Amount of setup	Range
WLAN	High	Some setup necessary on your WLAN device and in the web interface of the EXPLORER 710	Wireless connection. Up to 100 m depending on the transmitter in the computer and on the transmission conditions.
LAN	High	None (or very little)	Up to 100 m of cable

Router function

The terminal has a router function which routes traffic between the local network connected to the terminal and up to 11 BGAN network connections (also called PDP contexts on the BGAN network).

The router contains NAT (Network Address Translation) which allows sharing of a public IP address between a number of local network users.

Standard or Streaming data

The BGAN network supports different classes of data connection to the Internet. The main classes are **Standard data** and **Streaming data**.

- Using a **Standard data** connection, several users can share the data connection simultaneously. This type of connection is ideal for TCP/IP traffic such as e-mail, file transfer, and Internet and intranet access.
The user pays for the amount of data sent and received.
- Using a **Streaming data** connection, you get an exclusive, high-priority connection, ensuring seamless transfer of data. This type of connection is ideal for time critical applications like live video over IP.
The user pays for the duration of the connection (per minute charge).

To start or stop a data connection

By default, you must manually start data connections. However, for some types of connection you can enable **Automatic Context Activation (ACA)** in the web interface. With ACA enabled, the terminal automatically establishes a data connection when it is registered on the satellite network. See *Automatic Context Activation (ACA)* on page 81.

Display: For information on how to start and stop data connections using the display, see *To start or stop a data connection using the display* on page 28.

Web interface: For information on how to start and stop data connections with the web interface, see *To control data connections from web interface (BGAN)* on page 55.

Configuration: For information on how to configure the data connections, see *To set up your data connection packages* on page 79.

Bonding of terminals

You can connect two EXPLORER 710 terminals to obtain a higher bandwidth. This is useful for UDP connections such as video and audio transmissions.

Note that:

- Bonding is intended for **live streaming video over IP**. The service works with Inmarsat's HDR Streaming data connections and supports primarily UDP traffic. TCP/IP traffic will work, but with lower performance and only using one channel.
- A bonding connection requires two adjoining BGAN channels. In highly congested areas it might be difficult to get two available HDR channels ready for bonding. In those cases it is recommended to disable bonding and try to set up one HDR channel instead.

Note

A bonding server must first be set up, in order to receive and "reassemble" the two signals into one at the receiving end. You must know the server name, user name and password in order to set up the EXPLORER 710 terminals used for bonding.

You find the Bonding server application in the Cobham SYNC Partner Portal at www.cobhamsatcom.com, select **Cobham SYNC Partner Portal** and log in. Then select **Downloads > Product Software**. Under **Filter by category**, select **Land Mobile > Satcom > L-Band** and locate the **Bonding Server**.

Note NSD must be disabled for the Bonding function to work (NSD is disabled by default). See *To enable or disable Network Service Device (NSD)* on page 77.

Do as follows:

1. Configure the bonding settings on both terminals as described in *To set up channel bonding* on page 77. Make sure bonding is **enabled** for both terminals.
2. Make sure both terminals are in Router mode (see *To set up the connection mode* on page 74).
3. Connect a LAN cable between the two terminals, using the LAN connectors.
4. Switch on one of the two EXPLORER 710 terminals.
5. After about 20 seconds, switch on the other EXPLORER 710 terminal. The two terminals will now find each other and decide which terminal is “master” and which one is “slave”.
6. When the two terminals are ready, the display on the slave terminal reads **Bonding slave mode**. The master terminal automatically enables bonding connection packages in the display and in the web interface.

Note When you are using the bonding function, you can only start data connections from the master terminal.

7. Connect your user equipment to the master terminal.
8. From the master terminal, start the bonding connection package you want to use. For details, see *To start or stop a data connection* on page 33 or *To control data connections from web interface (BGAN)* on page 55.

When the display of the master terminal shows that the bonding connection package is running, you can start transmission from your connected equipment.

Note The MTU (Maximum Transmission Unit) for bonding connections is 1400 Bytes. The connected equipment (video codecs etc.) must be set up to match this.

If, at a later stage, you want to use the “slave” terminal without the bonding function, you must disconnect the two terminals and switch the “slave” terminal off and on again.

PPPoE (Point-to-Point Protocol over Ethernet)

Overview

You can establish a PPPoE connection to the BGAN network using the EXPLORER 710 system. Use PPPoE if you want to control your connection independently of the web interface.

Possible applications are:

- Connecting a router
- Connecting broadcast equipment, optionally through a PC
- Establishing a Pico cell for the use of cell phones

The drawing shows connections managed through PPPoE and web interface respectively.

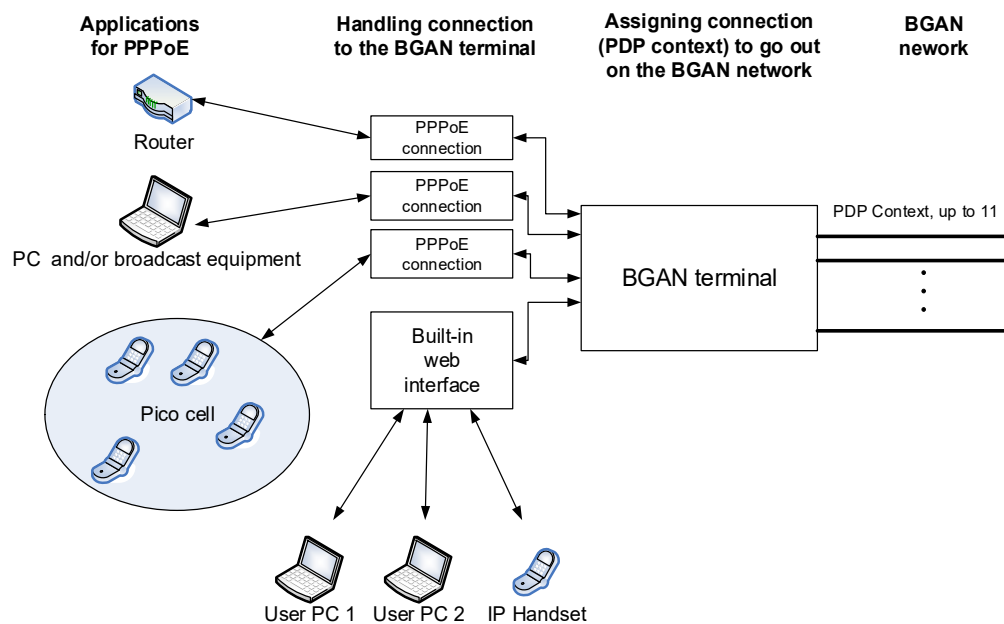

Configuring the connected equipment for PPPoE

How to configure your equipment depends on the type of equipment. Refer to the user documentation of the equipment. As a minimum, you need to configure the following parameters in your equipment in order to make PPPoE work with the terminal:

- User name and password.

The user name and password can be left blank (or insert user name: void and password: void). Then the registration on the Access Point is most commonly done in such a way that the data connection is established with a dynamic IP address from the airtime provider. To request a static IP (if subscribed to) from the Access Point you must type in the user name and password from your airtime subscription.

Note for MAC OS: User name and password are required. Use user name void and password void. This works for some ISPs. Contact your airtime provider for further information.
- For setups that have a check box for “Enable LCP extensions”, deselect this.

No further configuration is needed to make a Standard IP data connection to the Internet.

See the table below for information on how to configure specific services for your PPPoE connection.

If you need a certain service, for example a Streaming class, you must type in a specified text string when asked for a service name. The following table shows the service names supported by the terminal.

Text to type in the Service Name field	Function
(Blank)	Initiates a Primary Standard Data connection (default)
XBB:BACKGROUND	Initiates a Primary Standard Data connection (same as blank)
XBB:STREAM16K	Initiates a Primary Streaming 16 kbps connection
XBB:STREAM32K	Initiates a Primary Streaming 32 kbps connection
XBB:STREAM64K	Initiates a Primary Streaming 64 kbps connection
XBB:STREAM128K	Initiates a Primary Streaming 128 kbps connection
XBB:STREAM176K	Initiates a Primary Streaming 176 kbps connection
XBB:STREAM256K	Initiates a Primary Streaming 256 kbps connection
XBB:X-STREAM	Initiates a Primary X-Stream connection (from a minimum of 384 kbps up to approximately 450 kbps)
XBB:HDR_STREAM416K	Initiates a Primary Streaming 416 kbps (½HDR) connection
XBB:HDR_STREAM896K	Initiates a Primary Streaming 896 kbps (HDR) connection
XBB:HDR_STREAM416K_64K	Initiates a Primary Streaming 416 kbps (½HDR) upload and 64 kbps download connection
XBB:HDR_STREAM896K_64K	Initiates a Primary Streaming 896 kbps (HDR) upload and 64 kbps download connection
XBB:<AT String>	This allows the PPPoE clients to enter a full AT context activation string. Examples: XBB:AT+CGDCONT=1,ip,"bgan.inmarsat.com" XBB:AT+CGEQREQ=1,1,64,64,64,64

To access the terminal using AT commands

1. Connect your computer to the EXPLORER 710 terminal.
You may connect directly to the terminal or use a remote connection as described in the next sections.
2. On the connected computer, start a Telnet session.
3. Select TCP/IP and type in the IP address and port number.
 - For **local connection**, use the local IP address of the EXPLORER 710 (default 192.168.0.1) and port number 5454.
 - For **remote connection**, use the external IP address of the terminal (step 4 in the section *To get remote access from a trusted IP address (preconfigured)* on page 40). The port number for AT commands is normally 5454 but is defined in the Remote management page under AT commands (see *Prepare the terminal for remote management* on page 100).
4. When the connection is established, type in your AT commands.

To access the terminal from a remote location (BGAN only)

Remote access with SMS

You can perform a number of actions and some configuration on the EXPLORER 710 using SMS commands.

Note

The SMS commands require a BGAN connection. They cannot use a cellular connection.

1. Prepare the terminal for SMS commands as described in *Prepare the terminal for remote access with SMS* on page 102.
2. **Send an SMS** from a trusted phone number to the mobile number of the terminal. The text in the SMS must start with the SMS command and follow the syntax for the SMS commands. Note that the remote SMS password (default: **remote**) must be included with every command.

The following SMS commands are supported.

For an explanation of syntax and parameters, see *SMS remote commands* on page 145.

SMS command	Function
ACTIVATE	Activates BGAN data connections for the device(s) connected to the EXPLORER 710.
DEACTIVATE	Deactivates some or all the BGAN data connections for devices connected to the EXPLORER 710.
CLEAR	Deletes SMS messages in the EXPLORER 710.
GETINFO	Gets information from the EXPLORER 710 such as call time, data usage, GPS position and global IP address.
RESTART	Restarts the EXPLORER 710.
WATCHDOG	Gets or allows you to set the Connection watchdog parameters (Link monitoring).
ADVWATCHDOG	Gets or allows you to set the Terminal watchdog parameters.
ATCO	Allows you to send AT commands in an SMS to the EXPLORER 710 which returns the response in an SMS. Note: The ATCO command only supports a subset of the AT commands, see <i>ATCO commands</i> on page 151.
ADPWRST	Resets the EXPLORER 710 administrator password to admin .
WANMODE	Gets or allows you to set the WAN connection mode (BGAN or Cellular)

Remote access with the web interface

Note When using remote access, the web interface may take a long time to load the pages, because the Internet connection may be slow.

There are two methods of getting remote access to the web interface:

- Using the AT command `_IREMWEB`, e.g. sent in an SMS (ATCO command).
- Accessing an EXPLORER 710 that is pre-configured with trusted IP addresses.

The following sections describe these two methods.

Note Only one PDP context at a time can be used for remote web interface access.

To use AT commands to get remote access to the web interface

You can send the AT commands encapsulated in an SMS (ATCO commands). For details, see *Prepare the terminal for remote access with SMS* on page 102.

Note

If remote SMS command access has been disabled, you can enable it either using the web interface (*Prepare the terminal for remote access with SMS* on page 102) or using the AT command `_ISMSRMT` (*M2M related AT commands* on page 151). Note that you must have configured **at least one trusted phone number** that can send and receive SMS to and from the terminal.

Relevant command:

`_IREMWEB`

See *ATCO commands* on page 151 for syntax and parameters.

1. To use an SMS to allow access to the web interface for specific IP addresses, send the following command:

```
ATCO <resp_mode> <rsms_pwd> _IREMWEB=1,<ip address>[,<ip address>]
```

Example: `ATCO 2 remote _IREMWEB=1, 87.123.189.119`

In this example the command specifies:

- **2:** no immediate response, only when the global IP address is sent along.
 - **remote:** The remote SMS password
 - **1:** Enable remote access to web interface
 - **87.123.189.119:** The IP address that can get remote access to the web interface (if two IP addresses are listed, it is interpreted as a range of IP addresses).
2. The EXPLORER 710 should now return an SMS response with the external IP address of the terminal.

Example: `_IREMWEB: 81, Global IP: 161.30.181.31`

81 is the response code for a remote web connection that was set up successfully. It is followed by the global IP address, which is the IP address to enter in your browser to access the web interface from the remote device with the IP address you specified in the command.

3. On the remote computer, open your web browser.
4. In the address bar of your browser, enter the global IP address of the EXPLORER 710 (received in the response above).

You should now be connected to the built-in web interface of the terminal.

To get remote access from a trusted IP address (preconfigured)

Note This method requires that you initially have local access to the EXPLORER 710. If not, use the **_IREMWEB** command described in the previous section.

Initial local configuration

1. Connect a computer to the EXPLORER 710 and access the web interface locally.
2. Prepare the terminal as described in *Prepare the terminal for remote access with IP* on page 101.
3. Activate a data connection in one of the following ways:
 - Automatic Context Activation of a Standard data connection, see *Automatic Context Activation (ACA)* on page 81.
 - Manual activation of a data connection, see *To start or stop a data connection* on page 33.
4. Note the terminal's external IP address as follows:
 In the web interface on the locally connected computer, the external IP address of the terminal is shown in the tile with the connection you started in the previous step.
 This is the IP address you must use afterwards to access the terminal from your remote computer.

Note If Static IP is included in your airtime subscription, we recommend using this static public IP address for the terminal in order to provide easy access to the terminal. To use the static IP address, you must set the APN source to SIM default. For details, see *To change the APN for a connection package* on page 80.

Remote access to web interface:

1. Make sure your remote computer has access to the Internet.
2. On the remote computer, open your web browser.
3. In the address bar of your browser, enter the IP address of the terminal followed by a colon and the port number
http://<ip address>:<incoming port>.
 - <ip address> is the external IP address of the EXPLORER 710. The external IP address can only be obtained when a data connection (PDP context) is established. If a data connection is started, you can get the external IP address with the GETINFO SMS command, see *Remote access with SMS* on page 37.
 - <incoming port> is the port you defined in *Prepare the terminal for remote management* on page 100 (Incoming port for web application, default port 80).

Example: If the IP address of the terminal is 161.30.180.12 and the incoming port number defined in the Remote management page in the web interface is 80, enter **http://161.30.180.12:80**.

You should now be connected to the built-in web interface of the terminal.

Remote access with AT commands

1. Prepare the terminal for remote management as described in the previous section *Initial local configuration*.
2. Access the terminal as described in *To access the terminal using AT commands* on page 37.

Phone connection

Call types

Definition

The phone connection can be either a **Standard voice** connection or a **3.1 kHz audio** connection.

- For **outgoing calls**, the call type is **Standard voice** by default.
You can change the call type for your call to 3.1 kHz audio by dialing **2*** before the number.
- For incoming calls, you can set up in the web interface which call types you want to receive on the Phone, ISDN or LAN/WLAN interface (IP handset). Only the call types selected for an interface are received on that interface (by default, all call types are accepted).

When receiving calls, the mobile number determines which call type is used. In your airtime subscription you have one number for 3.1 kHz audio and one number for Standard voice. Remember that the call is only received on an interface if the call type used is selected for that interface.

For information on how to set up the call types in the web interface, see *To set up the interfaces* on page 63 and *To manage IP handsets or smartphones* on page 68.

To make or receive a phone call with EXPLORER 710

Smartphone, analog phone, ISDN phone or IP handset

First connect your phone to the relevant interface. For further information, see:

- Smartphone: *To connect your smartphone for making calls* on page 22
- analog phone: *To connect an analog phone* on page 24
- ISDN phone: *To connect an ISDN phone or modem* on page 25
- IP handset: *To connect a wired IP handset for making calls* on page 23

To make a call from the EXPLORER 710

If you are using a smartphone with the EXPLORER Connect app, first start the app and select **Satellite Phone** from the main menu.

To make a call, dial

00 <country code> <phone number> followed by **#** or off-hook key.

Example: To call Cobham SATCOM in Denmark (+45 39558800),
dial **00 45 39558800 #**

If you are calling with the EXPLORER Connect app, you may also select a number from the Contacts list (icon in bottom right corner from the dial page). Note that the contacts found here are the contacts of your smartphone, **not** of the EXPLORER 710.

If there was an error establishing the connection, the web interface and the display of the EXPLORER 710 show an error message.

To receive a call

By default, all devices connected to the EXPLORER 710 will ring when one of the mobile numbers is called. Note however, that this depends on the call type settings. See *Call types* on page 42.

Information on missed calls is stored in the call log. You can see the call log in the web interface (Control panel  > Logs > Call log).

To make a call to the EXPLORER 710

To make a call to a phone connected to the EXPLORER 710, dial + **<Mobile number>**

- + is the prefix used in front of the country code for international calls. This is **00** when calling from countries in Europe and from many other countries.
- **Mobile number.** The first part of the mobile number is always 870, which is the “country code” for the BGAN system. For information on the mobile numbers, refer to your airtime subscription.

Note

There are two mobile numbers, one for **3.1 kHz audio** and one for **Standard voice**.

Local numbers and special functions

Overview

There are a number of local numbers and dialing functions available in the EXPLORER 710.

The following list shows the allocated local numbers and special-purpose numbers for the EXPLORER 710.

Number	Function
00 followed by one of the numbers 1-199 and # or off-hook key	Short dial phone numbers in phone book.
0300 followed by # or off-hook key	Local call to analog phone.
0400 followed by # or off-hook key	Local call broadcast to all ISDN phones.
0 followed by one of the numbers 401-404 and # or off-hook key	Local call to one ISDN phone.
0 followed by one of the numbers 501-516 and # or off-hook key	Local call to one IP handset.
0900 followed by # or off-hook key	Local call broadcast to all handsets.

Apart from the numbers above, the EXPLORER 710 uses the following dialing prefixes:

- **1*** before the phone number will force the connection to use **Standard voice**.
- **2*** before the phone number will force the connection to use **3.1 kHz audio**.
- **#31#** before the phone number will hide the callers phone number to the recipient.
- ***31#** before the phone number will show the callers phone number to the recipient where it would otherwise be hidden, e.g. because the number is an ex-directory number.

To make local phone calls

You can make local calls between phones connected to the EXPLORER 710. For an overview of the available numbers, see the table in the previous section.

To make a local call, dial **<local number>** followed by **#** or off-hook key.

To use a Thrane IP Handset with the terminal

In addition to making calls, the Thrane IP Handset offers additional functions for use with a BGAN terminal.

Note

If you want to use the BGAN functions of the Thrane IP Handset you must enable them in the EXPLORER 710 web interface under **Advanced > Security**. See *Security* on page 108.

If you have a Thrane IP Handset connected to the terminal and it is enabled in the Advanced > Security page, you can use it to:

- Make calls over the BGAN network.
- Enter PIN/PUK for the terminal.
- View pending alarms.
- View event log.
- View current satellite status and signal strength.
- Start/stop connection packages (only for handset with number 0501).

BGAN-specific menu items:

Main menu

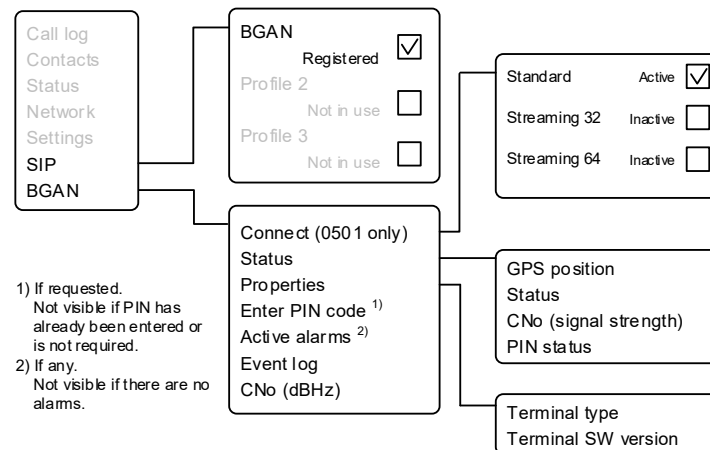

For details, see the user manual for the Thrane IP Handset.

To charge your smartphone or tablet

To charge your smartphone or tablet, connect it to the USB interface next to the power button on the EXPLORER 710. The connector is a standard USB A connector.



Note

There are two levels of charge current, 0.5 A or 2.0 A. Use the web interface to select the charge current for your device. See *USB interface setup*.

To see alerts

When an event requiring the attention of the user occurs, the display shows a warning icon . To see a list of active alerts in the display, do as follows:

1. From the display menu, select **Alerts**.
2. Select an alert to see details.

All alerts and other events are logged in the Event log

Terminal settings in display

To adjust the display

To adjust the display brightness and timeout, do as follows:

1. From the display menu, select **Settings > Display**.
2. Select **Brightness** and select the wanted level with **OK**.
3. Select **Settings > Display > Timeout**.
4. Select the period of time the display light should stay on after the last key is pressed.

Automatic power up

The default behavior of the EXPLORER 710 is to power up automatically when you connect external power. If you wish, you can change this power up mode, so that the EXPLORER 710 is only powered if the Power button is pressed. To switch between automatic and manual power up of the terminal, do as follows:

1. From the display menu, select **Settings > Power up mode**.
2. Select **Auto** or **Manual**.
 - Auto: The EXPLORER 710 powers up automatically when external power is applied
 - Manual: The EXPLORER 710 powers up only when the power button is pressed

To change the language in the display

The default language of the display is **English**. You can change the language to **French, German, Russian, Spanish, Chinese** or **Japanese**.

1. From the display menu, select **Settings > Language**.
2. Select the language you want.

To see properties of the EXPLORER 710 in the display

Using the display and keypad, you can see properties of the EXPLORER 710. Do as follows:

1. From the display menu, select **Properties**.
2. Select **IP address** to see the local IP address of the EXPLORER 710.
3. Select **Hardware** to see serial numbers and MAC addresses for the EXPLORER 710.
4. Select **Software** to see the software version of the EXPLORER 710.
5. Select **Conformity** to see a list of the standards to which the EXPLORER 710 conforms.
6. Select **IMEI** to see the IMEI number of the EXPLORER 710.

Tracking and location reporting

The EXPLORER 710 can be used for tracking purposes. You can set up the terminal to report its position to a server at certain time intervals.

To use the tracking feature you must either set up a tracking server or get a tracking solution from your service provider. The EXPLORER 710 must be set up to match this server. For information how to set up the EXPLORER 710, see *To set up tracking and location reporting* on page 88. Once set up on both sides, the EXPLORER 710 will send position reports to the server as specified.

Note | HDR streaming is not available when you are using the Tracking function.

To use the web interface

This chapter describes how to use the **web interface** to operate, set up and configure your system. It has the following sections:

- *Configuration with EXPLORER Connect app*
- *The web interface*
- *To enter the SIM PIN in the web interface*
- *To point the antenna (BGAN)*
- *To control data connections from web interface (BGAN)*
- *Status information*
- *The Control panel*
- *To use the logs*
- *Battery status information*
- *To set up the interfaces*
- *To manage connected devices (Traffic control)*
- *To manage IP handsets or smartphones*
- *Support features*
- *Terminal settings*
- *To set up your data connection packages*
- *Multiple data connections*
- *To set up tracking and location reporting*
- *Advanced LAN*
- *Advanced settings*
- *Optional: To set up cellular network for data*

Configuration with EXPLORER Connect app

If you want to use your smartphone to configure your EXPLORER 710, get the EXPLORER Connect app, which is available for iPhone or iPad (from the Apple Store) and for Android phones (from Google Play).

For an overview of the functions of the EXPLORER Connect app, see *The EXPLORER Connect app on page 9*.

To access the configuration settings, connect to the WLAN of the EXPLORER 710, start the **EXPLORER Connect** app and select **Terminal Access**. From this point you have access to the same settings as from the web interface.

Note

If you get a message saying Network Unavailable or Connection error it means you are not connected to the WLAN of the EXPLORER 710. For how to connect, see *To connect to the WLAN interface on page 20*.

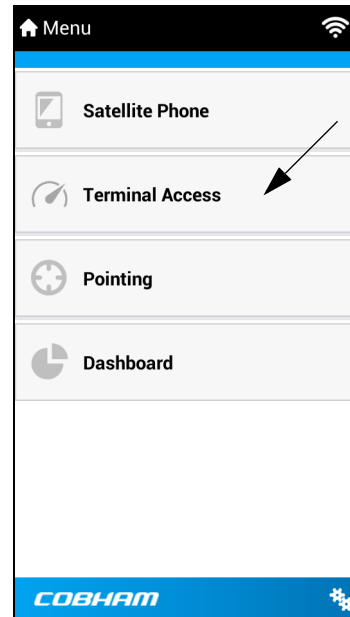

The web interface

What is the web interface?

The web interface is built into the terminal and is used for operating, setting up and configuring the system.

You can access the web interface from a computer with a standard Internet browser.

To access and navigate the web interface

To access the web interface

To access the web interface, do as follows:

1. Start up the terminal.
For details, see *To start up the EXPLORER 710 on page 16*.
2. Connect your computer to the terminal.
3. Open your browser and enter the IP address of the terminal in the address bar.
The default IP address of the terminal is **192.168.0.1**.

Note

Some parts of the web interface may not be accessible if the user permissions are limited. For information on how to set up user permissions, see *To set up user permissions on page 93*.

To change the language

When you have access to the web interface, if you want to display a different language than English, do as follows:

1. Select the Control panel  in the bottom right corner.
2. Select **Terminal settings**.
3. At **Language**, select a language from the drop-down list and click **Save**.

You can change the language to **French, German, Russian, Spanish, Chinese, Japanese** or **Portuguese**.

Overview of the web interface

When the web interface opens, the title bar shows the name of the product. The example below shows the **Support** page.

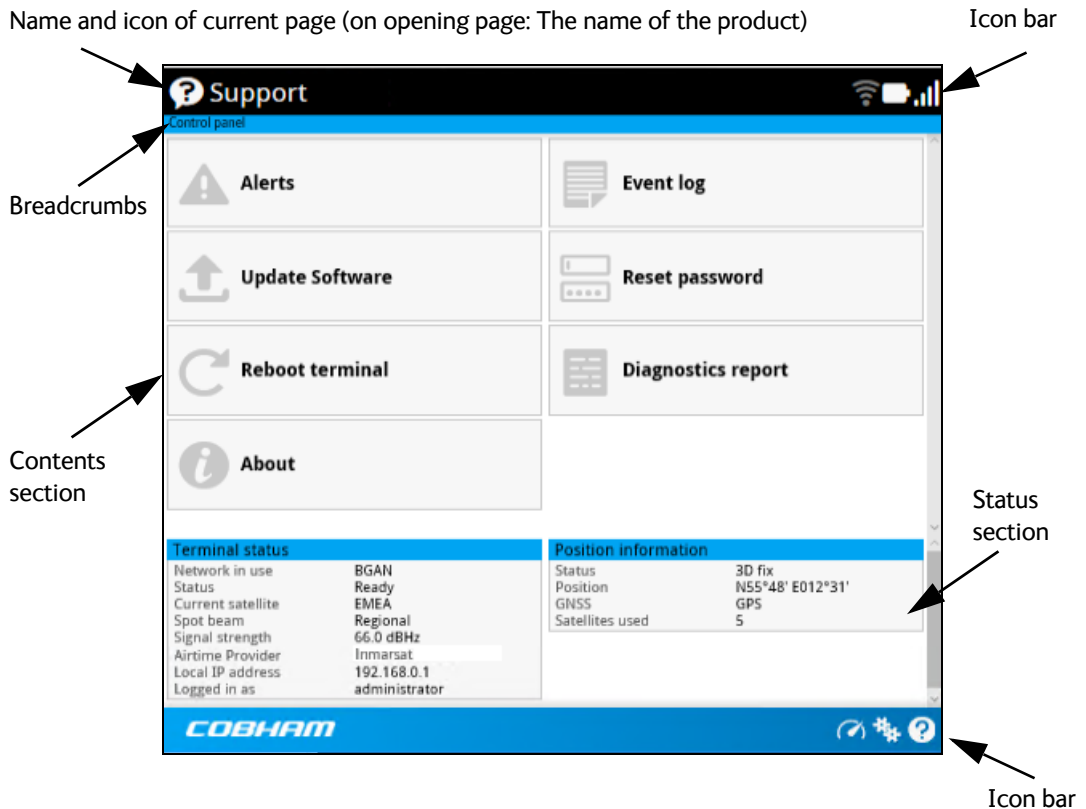















The web interface consists of the following sections.

- **Name** of current page. Tap or click to refresh the page.
- **Icon bars** at the top and bottom are present on all pages and hold icons that give access to status such as battery level and signal level as well as active alerts when relevant. It also holds the icon for the Control panel. For explanations of the icons, see the next section, *Icons in the icon bars*.
- **Breadcrumbs** right below the icon bar show the current location in the menu system and gives access to the higher levels in the menu.
- **Contents section** shows the contents of the selected page. This section is used for viewing or changing settings, or for performing actions. On the opening page, this section is used to start and stop data connections.
- **Status section** shows the status of the terminal and the network connection, position information, ongoing calls and data sessions etc. The Status section is not shown on small screens. If the screen is small (e.g. on a smartphone), you can show/hide the status by clicking  at the bottom of the page.

Icons in the icon bars

The icon bars are always available at the top and bottom of the web interface. Some of the icons are permanent while others are temporary.

Icon	Explanation
	Power status. The icon changes according to status. Click to see detailed battery status.
	Battery level
	Battery charging
	No battery. Running on external power.
	Signal level of the external network (BGAN or cellular).
	If Connection Mode is set to User selection in the terminal settings, click to select the network to use (BGAN or EXPLORER Cellular Modem).
	M at the signal bars shows that cellular network is active with the shown signal level.
	WLAN interface. Bright when WLAN is enabled, grayed when it is disabled. Click to access WLAN settings.
	The WLAN icon shows the number of connected devices.
	Help. Click to get context-sensitive help for the current page.
	Control panel. Click to access the settings.
	Startup page where you can start and stop data connections. Click to go to the startup page.
	The "1" at the icon shows that a BGAN data connection package is running.
	Status. If the screen is not large enough to show the status field, this icon appears at the bottom of the page. Click the icon to see status of the terminal and satellite connection. Click again to exit the status page.
	An alert is active. Click the icon to see a list of active alerts. Note that this icon will remain in the icon bar as long as the alert is still active.

To navigate the web interface

- **To access status and settings**, tap or click the relevant icon in the icon bar or select  to access the **Control panel**. The status or settings are displayed in the contents section.
- **To see your current location and to move back through the Control Panel menu**, use the breadcrumbs just below the icon bar.
- **To scroll through longer pages**, use the scroll bar or swipe.
- **To refresh the current page**, press Ctrl+F5 (PC) or Apple+R (Apple) or Cmd+R (Apple).

To enter the SIM PIN in the web interface

Do you need a SIM PIN?

Note

You may not have to enter a SIM PIN to access the terminal. This depends on whether or not the use of a SIM PIN is enabled on your SIM card.

The administrator can enable and disable the use of a SIM PIN. For details, see *To enable or disable the use of a SIM PIN on page 94*.

If a smartphone, tablet or computer is connected when you start up the terminal, you can access the web interface and enter the SIM PIN here.

To enter the SIM PIN

If your SIM card requires a PIN and the PIN has not yet been entered, you must enter it before you can make calls or access the Internet. Until you have entered the PIN you cannot access the satellite network, but you can still configure your terminal.

To enter the PIN, do as follows:

1. Access the web interface.
If the terminal needs a PIN, a popup window tells you to enter PIN.
2. Type in your PIN and click **OK**.

When the correct PIN is entered, the terminal is ready for pointing. When pointing is completed and the terminal is registered on the network, you are ready to make calls or access the Internet.

To cancel the SIM PIN

If you select **Cancel** when you are asked for a PIN, you can use the web interface as normal, but you will not be able to access the BGAN network to make calls or data sessions. Only emergency calls will be possible, and only if the network allows it.

To enter the PIN later, after canceling the first time, do as follows:

1. From the icon bar at the top, click .
The alert list opens.
2. Click **Resolve** next to **Enter PIN for BGAN**.
3. Type in your PIN and click **OK**.

To point the antenna (BGAN)

Before you can use the BGAN network, you must point the antenna in the direction of the satellite and find the best possible signal strength. For detailed information on the pointing procedure, see *To point the antenna (BGAN) on page 17*.

You can use the web interface to help you with the pointing process.

Pointing in web interface

To start the pointing process from the web interface, do as follows:

1. If the pointing process is not automatically started, select  (Control panel) and then **Point now**.
The signal strength is shown on the screen.
2. Turn and tilt the antenna slowly until you have obtained the highest possible signal strength.
3. Click **OK**.

The terminal will now try to register on the BGAN network.

To control data connections from web interface (BGAN)

The startup page of the web interface is used to start and stop data connections and to set up the data connections.

Note | If you are using the EXPLORER Cellular Modem instead of the BGAN network, see *Optional: To set up cellular network for data on page 110*.



To start and stop data connections

Note | By default, if you want to use a data connection, you must manually start it from the display or from the web interface. However, you can set up the EXPLORER 710 to automatically connect to the Internet when you connect equipment to the LAN or WLAN interface. See *Automatic Context Activation (ACA)*.



To start and stop data connections on your EXPLORER 710, do as follows:

1. In the opening page, locate the connection package you want to start.

Note | A connection package can consist of one or more connection types or two bonded EXPLORER 710 channels. For details, see *To set up your data connection packages on page 79*.

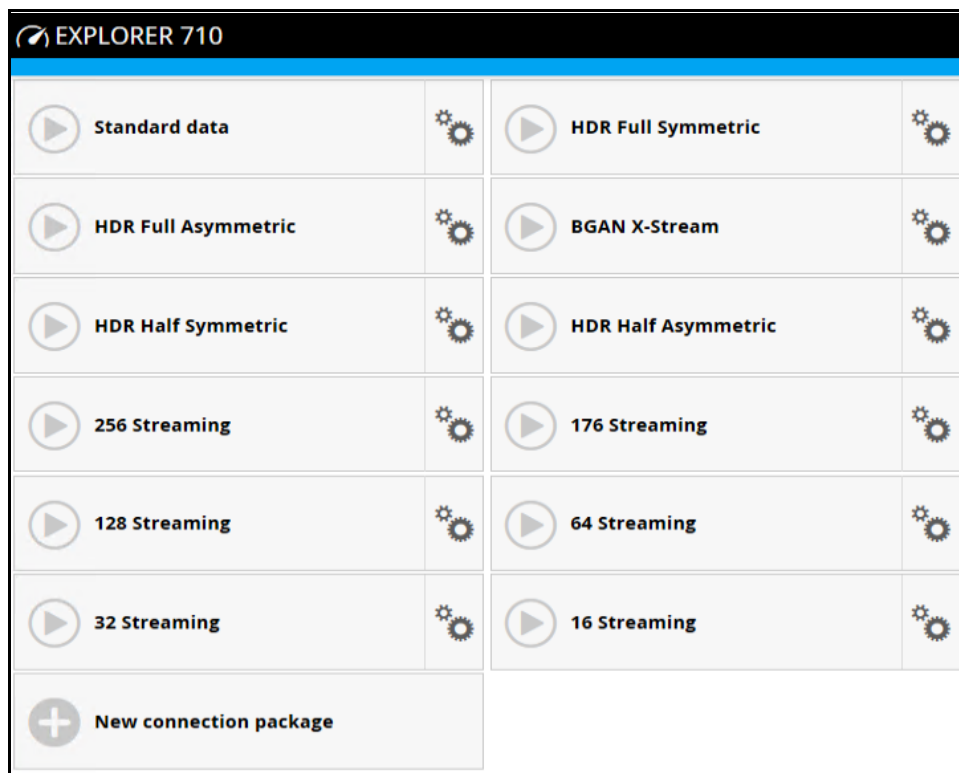
Note | The icons for starting  and stopping  connections are only active if the terminal is ready and registered on the BGAN network. Otherwise you cannot start data connections.





- Click  to start the connection. If more connections are included in the connection package, this will start all included connections. The connections icon at the bottom of the page shows  when a BGAN data connection package is running.

Note | Once a Streaming connection is started, the connection will run until you stop it. You will be charged for the time you are connected.

- Click  to stop the connection.

If data is temporarily suspended, e.g. due to a blockage, the icon on the active connection turns yellow instead of green, and the Status field shows Data suspended.

If the connection fails, the connection tile shows an exclamation mark  and an error message. The error message is also shown in the data log, see *Data log on page 61*.

When a connection is active, the icon changes to  and the tile for the active connection shows:

- IP address: The IP address that has been assigned by the service provider to this session.
- Transferred data: For Standard data, the tile shows the total amount of transmitted and received data since the connection was established.
- Connection duration: For Streaming data, the tile shows the total time the connection has been active.
- Bit rate: For Streaming connections, the tile shows the fixed bit rate.
 - For the Streaming classes with a **guaranteed bit rate**, the tile shows the guaranteed bit rate.
 - For the Streaming classes with a **dynamic bit rate** (BGAN X-Stream and HDR), the tile shows the currently available bit rate. Note, however, that the bit rate is adjusted according to the traffic on the connection. It takes approximately 15 seconds for the bit rate to be updated after traffic has started on the connection.



Default data connection types

By default, the following connections are available:

Name	Type of connection
<p>Standard data</p>	<p>Several users can share the data connection. This type of connection is ideal for TCP/IP traffic such as e-mail, file transfer, and Internet/intranet access.</p> <p>The user pays for the amount of data sent and received.</p>
<p>Streaming data</p> <p>The following Streaming classes are available: 16, 32, 64, 128, 176 or 256 Streaming BGAN X-Stream HDR Full Symmetric HDR Half Symmetric HDR Full Asymmetric (64 kbps download, Full HDR upload) HDR Half Asymmetric (64 kbps download, Half HDR upload) 2 x HDR Full Symmetric (bonding) 2 x HDR Half Symmetric (bonding)</p>	<p>An exclusive, high-priority connection, ensuring seamless transfer of data. This type of connection is ideal for time critical applications like live video over IP. The user pays for the duration of the connection.</p> <p>“Double-channels” available primarily for UDP traffic when two EXPLORER 710 terminals are bonded.</p>

You can use these connections as they are or build your own connection packages. The EXPLORER 710 also offers a bonding function, where you can connect two EXPLORER 710 terminals to double the bandwidth for UDP traffic. For set up of the connection packages, see the section *To set up your data connection packages on page 79*.

Status information

If the window is large enough, it shows a status field at the bottom of the page or in the right side of the page. If not, click  at the bottom of the page to show the status page. Click  again to return to the previous page.

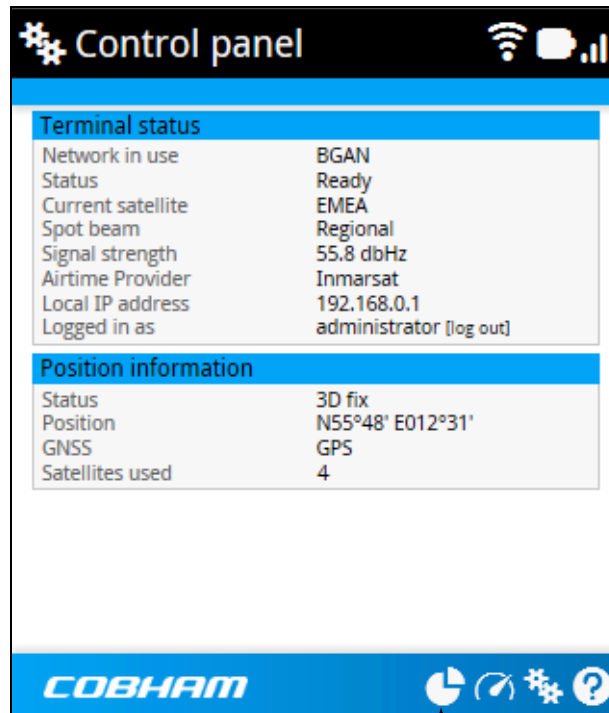

Toggle between status and contents page

The following status is available:

Note | Shown fields depend on the mode of the terminal (BGAN or Cellular)

Terminal status:

- Network in use: The network currently used (BGAN or Cellular).
- Status: The status of the BGAN network (or cellular network, if used). "Data" means a data connection is running. The status could also be e.g. "Registering" or "Ready".
- Current satellite: The BGAN satellite to which the EXPLORER 710 is currently registered.
- Spot beam: The type of BGAN spot beam currently used, e.g. "Regional" or "Narrow".
- Signal strength: The signal strength of the BGAN connection.
- Airtime Provider: The provider of the BGAN services.
- Network operator: The operator (or provider) of the Cellular network, if used.
- Local IP address: The local IP address of the EXPLORER 710. E.g. used to connect to the web interface.
- Logged in as: You can log in as Administrator. This field shows if you have administrator rights.

Position information:

- Status: Shows the status of the GNSS connection, e.g. if there is 2D fix, 3D fix or no fix.
- Position: The geographic position of the EXPLORER 710.
- GNSS: Shows which GNSS system is currently used to obtain the position.
- Satellites used: Shows how many GNSS satellites are used to obtain the position.

Data information (only shown if a data connection is running)

- EXPLORER Cellular Modem: Shows which type of data is running on the cellular connection.
- Standard data (or other connection package name): Shows which type of data is running within the connection package. A connection package may have more connections running simultaneously. For details on connection packages, see *To set up your data connection packages on page 79*.

Call information (only shown if a voice call is ongoing)

- Status: The status of the call, e.g. “Connected” or “Ringing...”.
- Call type: Shows whether the call type is Standard voice or Premium voice (3.1 kHz Audio).
- Call duration: The duration of the call.
- Originator: The phone number from which the call was made.
- Receiver: The phone number that receives the call.

The Control panel

The **Control panel** is used for accessing the settings and functions of your EXPLORER 710.

To open the **Control panel**, click  from the bottom right corner of the web interface.

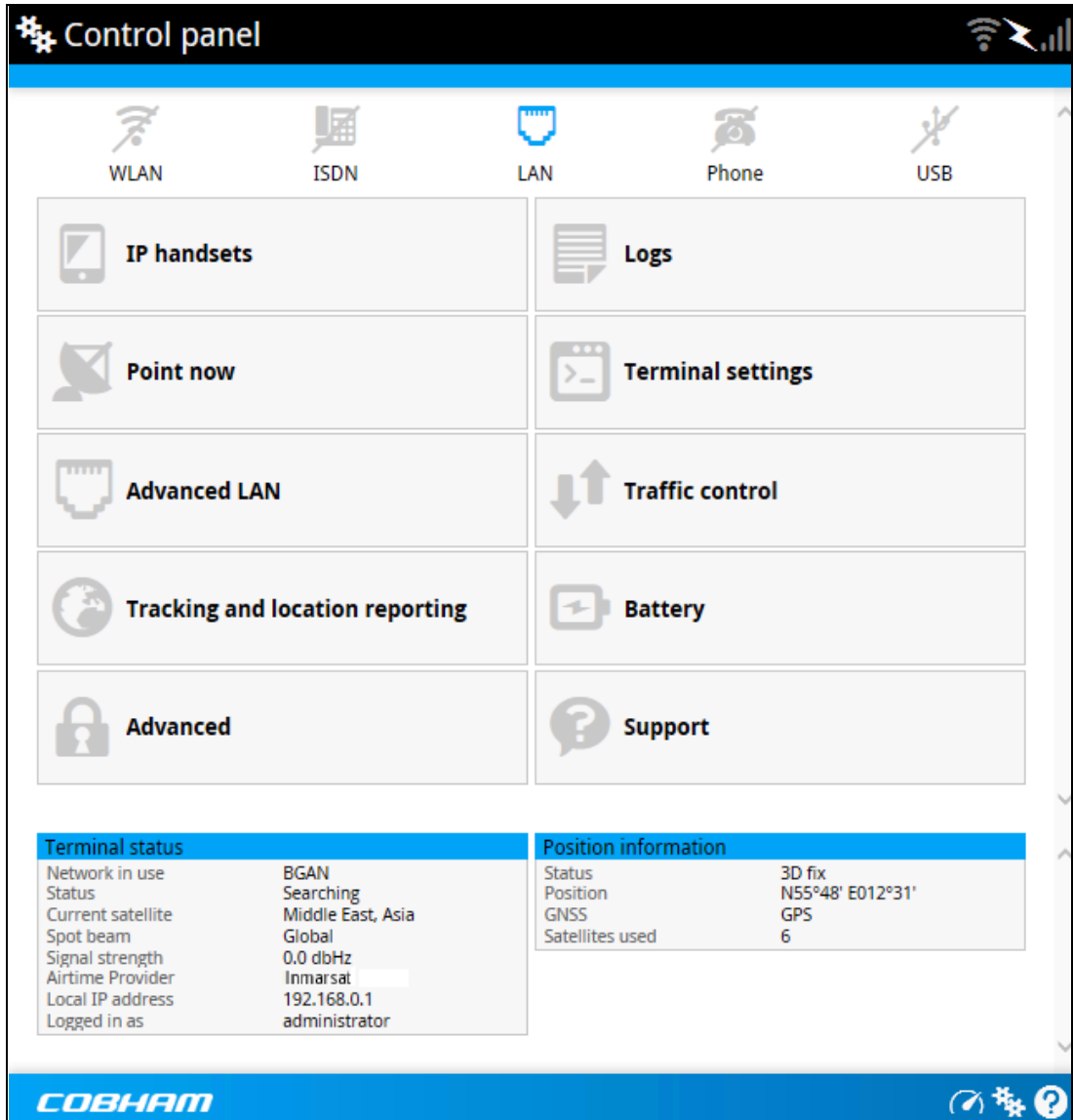

Control panel

WLAN ISDN LAN Phone USB

IP handsets Logs

Point now Terminal settings

Advanced LAN Traffic control

Tracking and location reporting Battery

Advanced Support

Terminal status		Position information	
Network in use	BGAN	Status	3D fix
Status	Searching	Position	N55°48' E012°31'
Current satellite	Middle East, Asia	GNSS	GPS
Spot beam	Global	Satellites used	6
Signal strength	0.0 dbHz		
Airtime Provider	Inmarsat		
Local IP address	192.168.0.1		
Logged in as	administrator		

COBHAM

To use the logs

To access the logs

To access the Logs, select  and select **Logs** from the menu. The Logs page contains:

- **Call log:** A list of all incoming, outgoing and missed calls since the log was last cleared.
- **Data log:** A list of all data sessions since the log was last cleared.
- **Total counters:** Totals for each type of service since the log was last cleared.

Date and time is the international UTC time, received from the satellite.

Call log

The Call log shows:

- **Outgoing calls** shows the start time, receiving end phone number, duration, type (Standard voice or 3.1 kHz audio) and, if Call charges have been entered, estimated charge of each outgoing call.
- **Received calls** shows the start time, calling phone number, duration and type (Standard voice or 3.1 kHz audio) of each incoming call.
- **Missed calls** shows the start time, calling phone number and type (Standard voice or 3.1 kHz audio) of each incoming call that was not received.

The Call log also shows the termination cause of each call.

To clear the Call log, click the **Clear call log** button at the top.

Data log

The Data log shows:

- Data usage (bytes), date and time and estimated charge of each Standard data session (if Call charges have been entered).
- Duration and type (such as 64 kbps, 128 kbps), date and time and estimated charge of each Streaming data session (if Call charges have been entered).
- Data usage, date and time of each cellular data connection.

The Data log also shows the termination cause of each data session.

To clear the Data log, click the **Clear data log** button at the top.

Total counters

The total counters show:

- **Call session totals** shows the total duration (hh:mm:ss) for each call type since the log was last cleared. It also shows the estimated call charge for each call type (if Call charges have been entered).
- **Data session totals** shows totals for each data connection type since the log was last cleared. For Standard data the totals are shown as amount of data transferred (kB) and for Streaming connections the totals are shown in duration (hh:mm:ss). It also shows the estimated charge for each data type (if Call charges have been entered).
- **Cellular session totals** (only present if the optional cellular modem is used) shows totals for each cellular data connection since the log was last cleared.

To reset the Total counters, click the **Reset total counters** button at the top.

Battery status information

Note | When two batteries are connected (internal and external), only one at a time is active.

To view the status of the internal and external battery, do one of the following:

- Click the battery symbol from the icon bar at the top of the page, or
- from the **Control panel** , select **Battery**.

The Battery page shows the **Status** (E.g. No battery, Charging, Discharging, Fully charged or Idle¹), the **Charge level** in percent, the **Estimated remaining usage time** (not shown when external power is connected) and the **Temperature**.

Note | The estimated remaining usage time can vary significantly, depending on usage. The remaining time will be shorter if the terminal is used heavily (more interfaces in use and more calls and data sessions active).

The estimated remaining usage time stated while the battery is Idle is the time that the terminal will run when the battery is active (discharging).

For more information on the EXPLORER 710 batteries, see



- *To insert the battery on page 12*
- *Normal use of the battery on page 116*
- *To recharge batteries on page 116*
- *To connect an extra, external EXPLORER 710 battery on page 117*
- *Accurate display of the battery capacity on page 117*
- *Battery specifications (internal battery) on page 103*

1. "Idle" in this case means the battery is not in use, e.g. because external power is applied while the battery is full, or an external battery is connected so only one of the batteries is active.



To set up the interfaces

LAN interface setup

The terminal has two LAN connectors. LAN#1 is with PoE (Power over Ethernet). To configure the LAN interface, do as follows:

1. In the **Control panel** , click the **LAN** icon  at the top of the page.
2. To enable the LAN interface, select **Enable**.

Note | It may take some seconds to enable the interface.



3. To enable Power over Ethernet (PoE) on LAN#1, select **Enable** next to **Power over Ethernet**. PoE is used e.g. for powering IP handsets. If you are not using PoE, you can save power by disabling PoE.
4. Click **Save**.
 -  A line through a grayed-out **LAN** icon means the interface is **disabled**.
 -  A blue **LAN** icon means the interface is **enabled**.

For a description of how to set up the **local network parameters**, see *Internet and LAN connection modes on page 75* and *Advanced LAN on page 90*.

WLAN interface setup

Note | The Internet settings entered in the Terminal settings page also apply for the WLAN interface. See *Internet and LAN connection modes on page 75*.

To configure the WLAN interface, do as follows:

1. In the **Control panel** , click the **WLAN** icon  at the top of the page.
2. To enable the WLAN interface, select **Enable**.

Note | It may take some seconds to enable the interface.

3. Next to **Region**, select the region you are located in.



Note | In some countries, the use of WLAN is not allowed. Before continuing, make sure WLAN is allowed and licensed in the country where you intend to use it.

4. Select the **Channel** number used for communication on the WLAN interface.
5. Select **Broadcast SSID** to show your WLAN access point to other users. If you **clear** the box, your WLAN access point is hidden.
6. Type in the **SSID**.
The SSID is a max. 32 character text identifying the wireless local area network. All wireless devices on a WLAN must use the same SSID in order to communicate with each other. The default SSID is **EXPLORER710**.
7. Select the **Security** standard. You may select one of the following encryption standards:

- None (no encryption is applied)
 - WEP-40/64
 - WEP-104/128
 - WPA-TKIP
 - WPA-2-AES (selected by default)
8. Next to **Key type**, select **Hexadecimal** or **Text**.
The encryption key must normally be a hexadecimal code. However, if you are using WPA-TKIP or WPA2-AES encryption (default) you can choose to use a text string, which may be easier to memorize.
9. Type in the **Encryption key** for the selected Security standard (not applicable if security mode = None). The default encryption key is the **serial number** of the EXPLORER 710. You can find the serial number under **Control panel > Support > About** or on the label on the EXPLORER 710.

Important



Change the encryption key to a personal code in order to keep your WLAN connection secure and protected!

10. Click **Save**.
-  A line through a grayed-out **WLAN** icon means the interface is **disabled**.
 -  A blue **WLAN** icon means the interface is **enabled**.

For a description of how to set up the **local network parameters**, see *Internet and LAN connection modes on page 75* and *Advanced LAN on page 90*.



Phone interface setup

To configure the Phone interface, do as follows:

1. In the **Control panel** , click the **Phone** icon  at the top of the page.
2. To enable the Phone interface, select **Enable**.



Note

It may take some seconds to enable the interface.



3. Set the call type for incoming calls.
You can select **Standard voice** or **3.1 kHz audio** or both.
 - If you select both, any connected device will react (ring) on incoming calls.
 - If you select e.g. Standard voice, the Phone interface will only react on calls made to the Standard voice phone number.
4. Select the **Preferred outgoing call type**.
The selected type will be used by default, if possible, for any outgoing call.
5. If needed, change the **Phone line impedance**. You have the following options:
 - EURO (270R/150nF) (default option)
 - USA/Canada/Japan (600R)
6. Click **Save**.
 -  A line through a grayed-out **Phone** icon means the interface is **disabled**.
 -  A blue **Phone** icon means the interface is **enabled**.

ISDN interface setup

To configure the ISDN interface, do as follows:

1. In the **Control panel** , click the **ISDN** icon  at the top of the page.
2. Click the ISDN number you want to change settings for.
3. To enable the ISDN interface, select **Enable (all ISDN devices)**.



Note | It may take some seconds to enable the interface.

4. Set the call type for incoming calls.
You can select **Standard voice**, **3.1 kHz audio**, **UDI** and/or **RDI**.
An incoming call to the ISDN interface will only make the connected device ring if the call type used for the call is selected here.
5. Click **Save**.
 -  A line through a grayed-out **ISDN** icon means the interface is **disabled**.
 -  A blue **ISDN** icon means the interface is **enabled**.



USB interface setup

Note that the USB interface is a Host interface, primarily used for charging smartphones, for recovery software upload or for connecting an EXPLORER cellular modem.

To configure the USB interface, do as follows:

1. In the **Control panel** , click the **USB** icon  at the top of the page.
2. To enable the USB interface, select **Enable**.

Note | It may take some seconds to enable and disable the interface.

3. Select the **Charge current**.
Select **0.5 A** or **2.0 A**, depending on the specifications for the device you are going to connect.
4. Click **Save**.
 -  A line through a grayed-out **USB** icon means the interface is **disabled**.
 -  A blue **USB** icon means the interface is **enabled**.

To manage connected devices (Traffic control)

By default, traffic control is disabled, which means that all traffic is allowed.

With the Traffic control function you can get an overview of devices connected to your EXPLORER 710 and control which devices you want to connect. You can also select whether or not they should be allowed to use BGAN or cellular network. Note that the available settings depend on whether or not you are logged in as administrator.

Note | The cellular modem setting is only available if an EXPLORER Cellular Modem is inserted in the EXPLORER 710.

Traffic control (Non-administrator user)

To set up traffic control, do as follows:

1. In the **Control panel** , click **Traffic control**.
A list of connected and added devices appears.



2. Click your connected device to see MAC address and IP address and to change the name or block/allow the use of BGAN or Cellular network. See the next section.

To block BGAN or cellular traffic or edit the name for your device

Note | You can only change these settings if traffic control is enabled. If the administrator has disabled traffic control, all traffic is allowed.

1. In the **Traffic control** page, click your connected device.
The page shows the name, MAC address, IP address and traffic rule for the device.
2. Select **Block BGAN traffic** or **Block Cellular traffic** (if available), if you want to deny access to BGAN or cellular network for your device.

Note | If it is already blocked by the administrator, this setting is not editable.

3. At **Name**, type in the name you want for your device.
4. Click **Save**.

Traffic control (Administrator)

When you are logged in as administrator (or administrator password is disabled), the Traffic control setup offers more options. To set up traffic control as administrator, do as follows:

1. Log in as administrator (or make sure administrator password is disabled).
2. In the **Control panel** , click **Traffic control**.
A list of connected and added devices appears.
3. Click the **Enable** button to enable Traffic control.
By default Traffic control is disabled, which means all devices are allowed access.

Note | When you enable traffic control, BGAN is blocked by default for all new devices.
To change the default settings, see the next section.

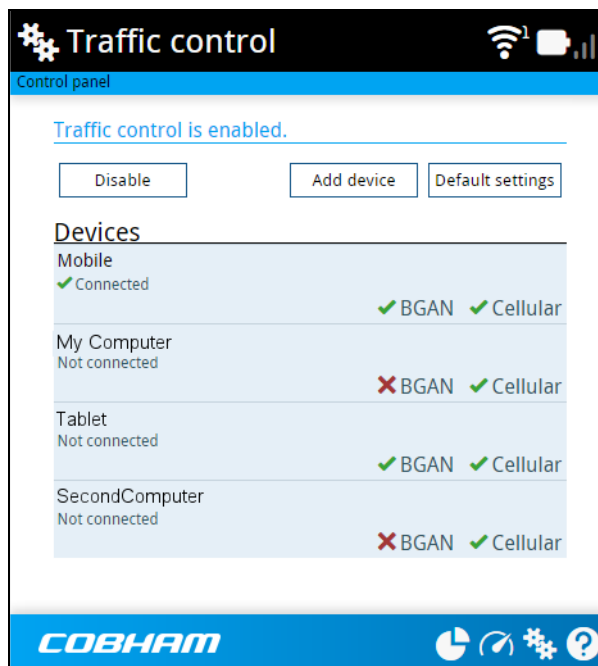

To change the default settings for all devices

Important | All devices in the list are updated with the default settings when you click Save.

1. Click the button **Default settings**.
2. Select **Block BGAN traffic** or **Block Cellular traffic** (if available) if you want to deny access to BGAN or cellular network for all devices. With this option selected, only the administrator will be able to allow access for selected or all devices.
3. Click **Save**.
All devices in the list will now have the new default settings.

To block or allow BGAN or cellular traffic or edit the name for a device

1. In the **Traffic control** page, click the device you want to set up.
The page shows the name, MAC address, IP address and traffic rule for the device.
2. Select **Block BGAN traffic** or **Block Cellular traffic**, if you want to deny access to BGAN or cellular network for the selected device.
If you want to **allow** access, clear the box. The selected device will then be able to access the network, even if it is blocked in the default settings (see previous section).
3. At **Name**, type in the name you want for your device.
4. Click **Save**.

Reset to default: You can reset the settings for the device to the default settings (see previous section).

- If the device is connected and you click the button **Reset to default**, the traffic rules will be reset to the default values set in *To change the default settings for all devices on page 67*, but the name remains the same.
- If the device is not connected and you click the button **Reset to default**, the device is removed from the list.

To Add a device

When you connect a device, it is automatically added to the list using the default settings. If you want to add a device for later use, do as follows:

1. In the **Devices** page, click the **Add device** button.
2. Type in the **Name** and the **MAC address** for the device.
3. Select **Block BGAN traffic** or **Block Cellular traffic**, if you want to deny access to BGAN or cellular network for the selected device.
If you want to allow access, clear the box. The selected device will then be able to access the network, even if it is blocked in the default settings (see previous section).
4. Click **Save**.

When the device with this MAC address is connected, it will appear with the entered name in the list, and access will be allowed or denied depending on the setting in this page.

To manage IP handsets or smartphones

Overview

This section describes how to manage smartphones and IP handsets connected to the EXPLORER 710.

The terminal supports connection of up to 16 IP handsets or smartphones. The WLAN interface supports connection of up to 10 units. Each phone must have a local number in the range 0501 to 0516 as well as a unique password. For details, see the next section.



For details on SIP settings and how to connect your phone to the LAN or WLAN interface, see *To connect a phone using LAN or WLAN on page 22*.

To manage IP handsets or smartphones in your EXPLORER 710

Do as follows:

1. Connect your smartphone to the WLAN interface of the terminal or your IP handset to the LAN#1 interface. For details, see *To connect a phone using LAN or WLAN on page 22*.
2. In the web interface, select  (Control panel) > **IP handsets**.
3. Click the tile for the handset number you want to manage.
4. Select **Enable** to enable the handset.

Note | It may take some seconds to enable the handset.

-  on the tile for your handset means the handset is **disabled**.
 -  on the tile for your handset means the handset is **enabled**.
5. To change the **Password**, simply type in the new number.
 6. Set the call type for incoming calls.
You can select **Standard voice** or **3.1 kHz audio** or both.
 - If you select both, the handset will react (ring) on incoming calls.
 - If you select e.g. Standard voice, the handset will only react on calls made to the Standard voice phone number of your EXPLORER 710.
 7. Select the **Preferred outgoing call type**.
The selected type will be used by default, if possible, for any outgoing call from this handset.
 8. Click **Save**.
 9. In the smartphone or IP handset, enter the local number and the password you just entered in the EXPLORER 710. See the documentation for your handset for details.

Note | The user name is also the local number for the handset.

The handset remains in the list after disconnecting. When the handset is connected again, it is automatically recognized and ready for use, if enabled.

Thrane IP Handset and access to BGAN profile and menu

If you want the terminal to support BGAN profile and menu in Thrane IP handsets, you must set this in the **Advanced > Security** page. Refer to *Security on page 108* and *To use a Thrane IP Handset with the terminal on page 45*.

Support features

To open the Support page, select  (Control panel) > **Support**.

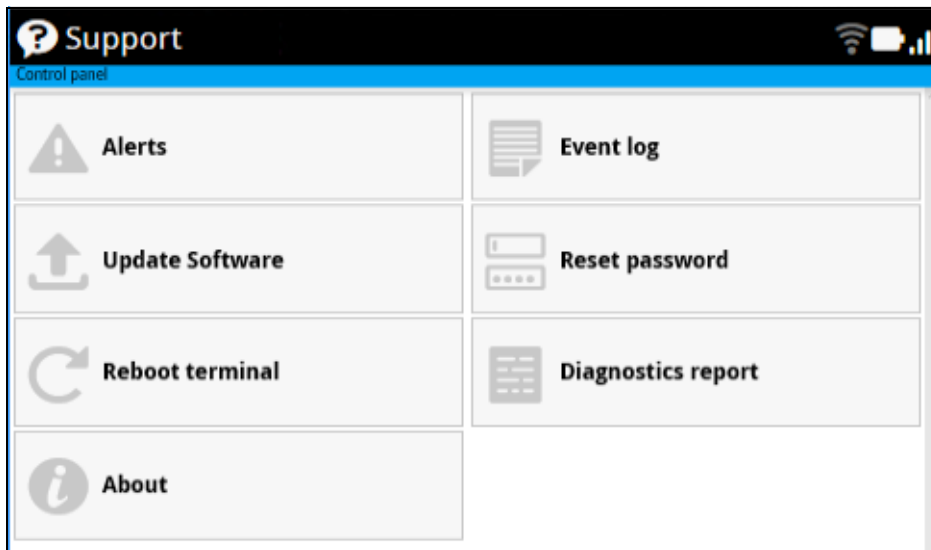

To view the Alerts

When an alert is registered, the web interface shows a warning icon  in the icon bar as long as the alert is active. The **Alerts** list only shows alerts that are currently active.

1. To view the alerts, click  from the icon bar at the top of the web interface, or select **Alerts** from the **Support** page.

The **Alerts** page shows a detailed list of active events including the time of the first occurrence, ID and severity of the event message, and a short text describing the error. For more information on the event messages, refer to *List of messages on page 126*.

To view the Event log

The Event log shows events that occurred in the past and are no longer active. It includes events of informational character describing normal phases of operation for the terminal, and also alerts that have appeared in the Alerts list.

To view the event log, select **Event log** from the **Support** page.

To create a diagnostics report

The diagnostic report contains relevant information for troubleshooting. When contacting your supplier for support, please enclose this file. To generate a diagnostic report, do as follows:

1. From the **Support** page, click **Diagnostics report**.
2. Click **Generate report**.

Note | It may take a few minutes to generate the report.

3. Select **Download report**.
4. Choose a location for the file and save it.

To update software

Important | If the battery power is 25% or less you must connect DC power to the terminal before starting the software update. Once connected, do not remove DC power until the software update is completed.

To update the software in the EXPLORER 710, do as follows:

1. Download the new software¹ or acquire the software from Cobham SATCOM and save it on your computer.
2. Open the web interface and enter the Control panel .
3. Click **Support > Update software**.
4. Click **Update software...**
5. Browse to the new software version and click **Open**. The software file has the extension ".tiff".
6. The terminal restarts and completes the software update.

Note | The update procedure takes some minutes to complete. During the software update, the Status LED is flashing blue.

You can check the software version under **Control panel > Support > About**.

If, for some reason, you cannot upload software using the web interface, you can also use the USB interface. For details, see *To update software with USB on page 114*.

1. You can download the software from the Cobham SYNC Partner Portal at www.cobhamsatcom.com select **Cobham SYNC Partner Portal** at the top, and then **Downloads > Product Software**. Locate the EXPLORER 710 software.

To reset the administrator password

If you have forgotten the administrator password, do as follows:

1. Contact your supplier for a reset code.
Report the serial number and IMEI number of the terminal.
You can find the serial number and IMEI number in the display on the terminal by selecting the menu  and then **Properties**.
2. After receiving the reset code from your supplier, select **Reset password** from the **Support** page.
3. Type in the reset code obtained from your supplier and click **Reset**.
4. The password is disabled.

You now have access to all settings. If you want to use a password, enable the password as described in *To disable the administrator password on page 92*.

To restart the terminal

If you want to restart the terminal, do as follows:

1. From the **Support** page, select **Reboot terminal**.
2. Click to confirm the reboot.

The terminal restarts. Note that this is the equivalent to switching the terminal off and on again.

About

The **About** page shows the **Serial number**, **IMSI number**, **IMEI number** and **software version** of your EXPLORER 710. It also shows your **Help desk** information, if it has been entered under Advanced > Help desk.

To access the About page, select **Support > About**.

Terminal settings

To configure the terminal settings, select  (Control panel) > **Terminal settings**.

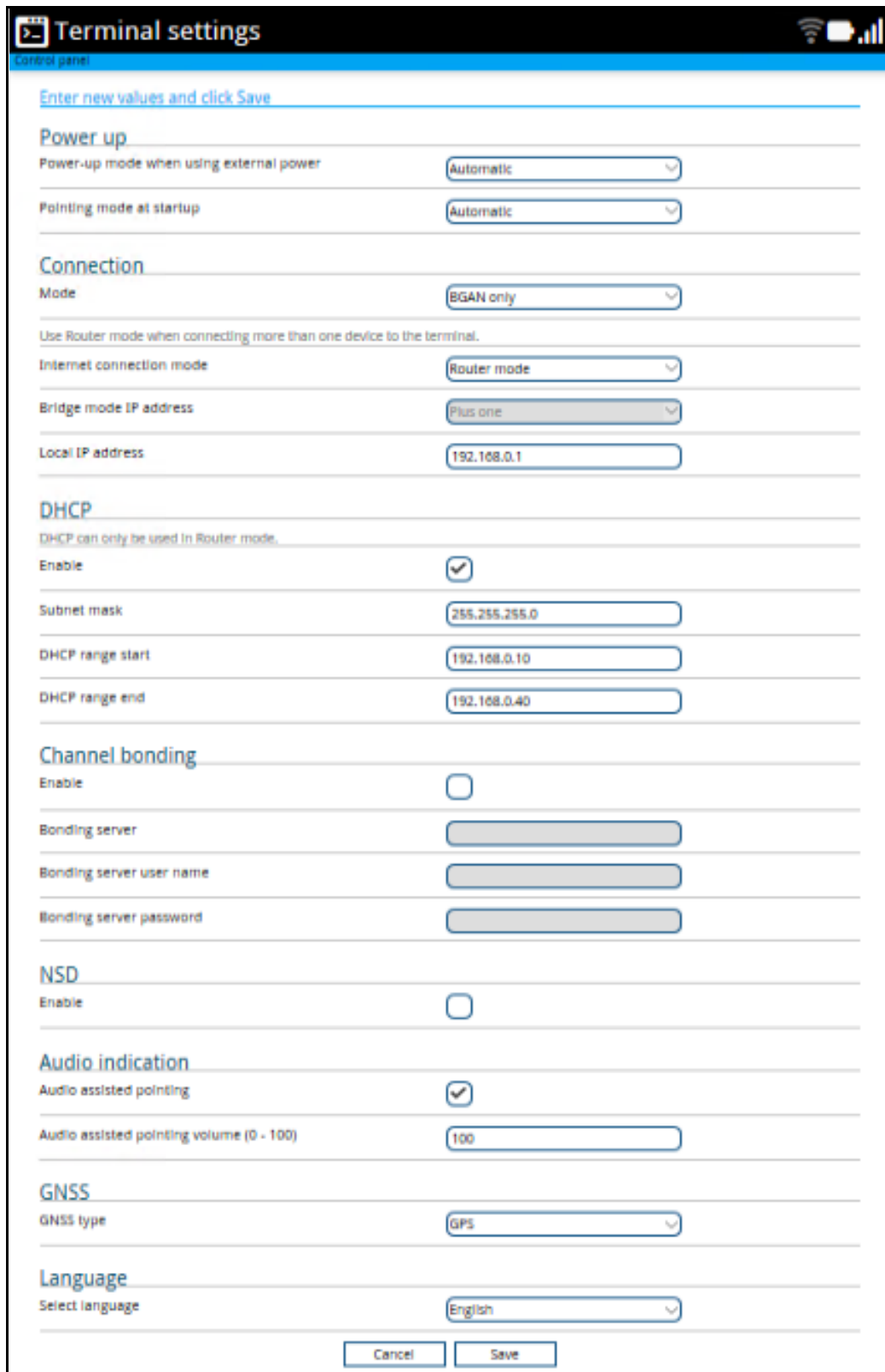

Terminal settings
Control panel

Enter new values and click Save

Power up

Power-up mode when using external power

Pointing mode at startup

Connection

Mode

Use Router mode when connecting more than one device to the terminal.

Internet connection mode

Bridge mode IP address

Local IP address

DHCP

DHCP can only be used in Router mode.

Enable

Subnet mask

DHCP range start

DHCP range end

Channel bonding

Enable

Bonding server

Bonding server user name

Bonding server password

NSD

Enable

Audio indication

Audio assisted pointing

Audio assisted pointing volume (0 - 100)

GNSS

GNSS type

Language

Select language

Power-up mode with external power

You can set the terminal to automatically power up when external power is applied.

1. In the **Terminal settings** page, locate **Power up**.
2. Under **Power-up mode when using external power**, select **Automatic** or **Manual**.
 - Automatic means the terminal powers up automatically when external power is applied.
 - Manual means you must use the power switch to power the terminal.
3. Click **Save**.

Pointing at start-up

You can set up the EXPLORER 710 to automatically register on the BGAN network at start-up. This is useful e.g. for semi-fixed or fixed installation, where the EXPLORER 710 is not moved around between start-ups. See *Fixed antenna installation on page 29*.

1. In the **Terminal settings** page, locate **Power up**.
2. Under **Pointing mode at start-up**, select **Automatic** or **Manual**.
 - If the EXPLORER 710 is moved around between each power up, select **Manual** from the drop-down list. With this setting, the terminal will go through the pointing procedure every time the terminal is powered.
 - If the EXPLORER 710 antenna is placed in a fixed position and the signal strength is sufficient, select **Automatic** to make the EXPLORER 710 automatically register on the satellite network when the terminal is powered.
3. Click **Save**.

To set up the connection mode

Mode (select network)

The EXPLORER 710 can use a cellular network as an alternative to the BGAN network. For details, see *Optional: To set up cellular network for data on page 110*.

To set up which network you want to use when starting up the EXPLORER 710, do as follows:

1. In the **Terminal settings** page, locate **Connection**.
2. At **Mode**, select from the drop-down list which mode you want the EXPLORER 710 to start up in. You have the following options:
 - **BGAN only** (default): The EXPLORER 710 uses BGAN only. You cannot use a cellular connection.
 - **Cellular modem if available at power-up**: The EXPLORER 710 uses cellular network if it is available at startup (that is if the EXPLORER Cellular Modem is inserted and the cellular network is found)
 - **Cellular modem only**: The EXPLORER 710 only uses the cellular network, not BGAN. If an EXPLORER Cellular Modem is not connected, or if the cellular network does not work for some reason, you cannot access any network.

- **User selection:** Every time the EXPLORER 710 starts up you must select which network you want to use. You cannot access any network until you have made the selection.

Internet and LAN connection modes

In the web interface you can set up the Internet connection mode and the IP addressing between the EXPLORER 710 and devices connected to the EXPLORER 710. The EXPLORER 710 has a built-in DHCP server which can be used to dynamically assign IP addresses to devices connected to the EXPLORER 710.

The drawing below shows examples of the IP addressing in router mode (default setup) and Bridge mode.

Note Bridge mode is not supported for connections to cellular network.

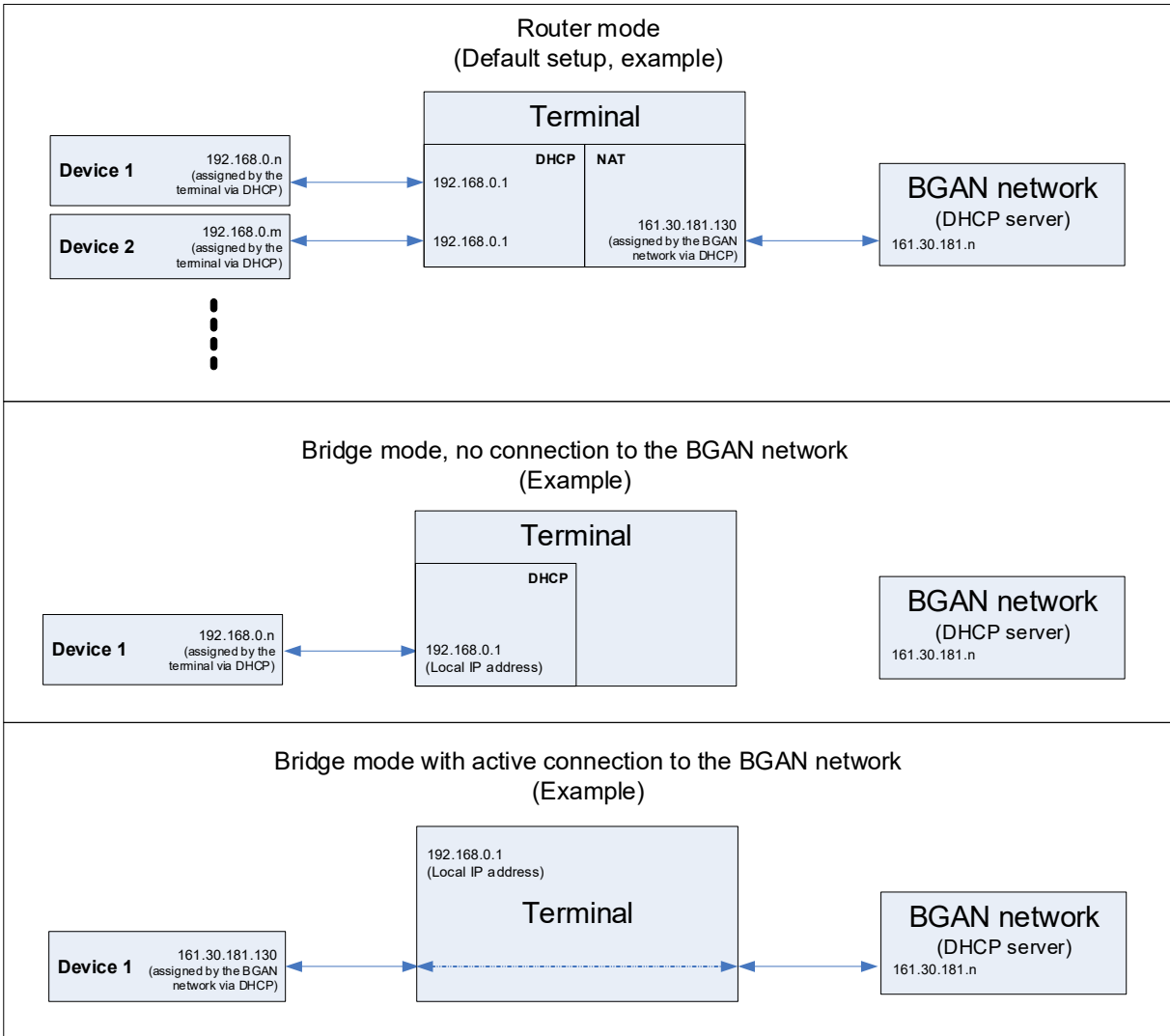

To set up the Internet connection mode of the EXPLORER 710, do as follows:

1. From the **Terminal settings** page, locate **Connection**.
2. At **Internet connection mode**, select **Bridge mode** or **Router mode**. Router mode is the default setting and is recommended for most purposes.
 - Select **Router mode** if one or more computers are connected and the EXPLORER 710 should act as a router. When Router mode is selected, the EXPLORER 710 uses the built-in NAT module for making the necessary address translations.
 - Select **Bridge mode** if only one computer is connected, and the EXPLORER 710 should act as a modem, or more than one computer is connected using an external router.

Note

Do **not** connect more than one computer in Bridge mode, unless you have an external router.

3. If you selected **Bridge mode**, select under **Bridge mode IP address** how the terminal's IP address should be assigned.
 - **Dynamic** example: If the IP address assigned by the DHCP server to the locally connected equipment is 10.30.27.130, the terminal will get the IP address 10.40.27.130. (in most cases it will be 10 added to the second octet of the assigned IP address).
 - **Plus one** example: If the IP address assigned by the DHCP server to the locally connected equipment is 161.30.181.130, the terminal will get the IP address 161.30.181.131 (the assigned IP address plus one).
4. Under **Local IP address**, type in a new IP address if you want to change the Local IP address of the terminal. This is the address used to access the web interface. The default IP address is **192.168.0.1**.

Important

A number of IP addresses are reserved for internal use. Do not assign any of the IP addresses listed in *List of reserved IP subnets on page 133*.

5. Under **DHCP**, select **Enable** (recommended for most purposes).
 - If you select **Enable**, the terminal assigns dynamic IP addresses to devices connected to the terminal.
 - If you **disable DHCP** you need to set up a static IP address in the connected device.
6. If you want to change the **Subnet mask** for the local network of the terminal, type in the new network mask. The default network mask is **255.255.255.0**.
7. Under **DHCP range start** and **DHCP range end**, type in the range of IP addresses that should be assigned to locally connected equipment.
8. Click **Save**.

To set up channel bonding

You can connect two EXPLORER 710 terminals to obtain a higher bandwidth for UDP traffic. First set up each of the two terminals as described below.

Note A bonding server must first be set up, in order to receive and reassemble the two signals into one at the receiving end. You must know the server name, user name and password in order to set up the EXPLORER 710 terminals used for bonding. You find the Bonding server application in the Cobham SYNC Partner Portal at www.cobhamsatcom.com, select **Cobham SYNC Partner Portal** at the top and log in. Then select **Downloads > Product Software**. Under **Products**, select **Land Mobile > Satcom > L-Band** and locate the **Bonding Server**.

1. In the **Terminal settings** page, locate the **Channel bonding** section.

Channel bonding	
Enable	<input checked="" type="checkbox"/>
Bonding server	<input type="text" value="10.0.0.1"/>
Bonding server user name	<input type="text" value="My User Name"/>
Bonding server password	<input type="text" value="My Password"/>

2. Select **Enable** to enable channel bonding.

Note NSD must be disabled for the Bonding function to work (NSD is disabled by default). See *To enable or disable Network Service Device (NSD) on page 77*.

3. At **Bonding server**, enter the name of the server used for the bonding function. You can type either the name or the IP address of the server.
4. Enter the user name and password for the server.
5. Click **Save**.
6. Connect and start up the two EXPLORER 710 terminals as described in *Bonding of terminals on page 33*.

To enable or disable Network Service Device (NSD)

If you have an Inmarsat GX system together with your EXPLORER 710 and you want to use the EXPLORER 710 as backup when the GX service is not available, you can acquire a Network Service Device from Inmarsat. The NSD will use a PPPoE connection to allow your system to use the BGAN service when your system is out of GX spot beam coverage. To enable NSD, do as follows:

1. In the **Terminal settings** page, locate the **NSD** section.
2. Select **Enable** if you want to use an NSD with your EXPLORER 710.

For information on PPPoE, see *To change the APN for PPPoE on page 91*.

To enable or disable the pointing sound

The EXPLORER 710 can make a sound to guide you through the pointing procedure (default enabled). To enable or disable the pointing sound, do as follows:

1. In the **Terminal settings** page, locate the **Audio indication** section.
2. Select **Audio assisted pointing** if you want to use a pointing sound to assist your pointing process.
3. At **Audio assisted pointing volume (0 - 100)** type the volume level you want for the pointing sound.
4. Click **Save**.

To select the type of navigation system (GNSS)

To select which navigation system to use with your EXPLORER 710, do as follows:

1. In the **Terminal settings** page, locate the **GNSS** section (Global Navigation Satellite System).
2. Select **GPS** or **GLONASS**.
3. Click **Save**.

Note | It may take some minutes for the EXPLORER 710 to change the navigation system.

To select the language

The default language of the web interface is **English**. You can change the language to **French, German, Russian, Spanish, Chinese, Japanese** or **Portuguese**.

To change the language, do as follows:

1. In the **Terminal settings** page, locate the **Language** section.
2. Select a language from the list and click **Save**.

To set up your data connection packages

Note

You must be logged in as administrator in order to change, delete or create connection packages.

There are different types of connection packages for different purposes:



- **Shared connection**, see *To create a shared connection package on page 83*.
This is a shared data connection package, which may include different connections (PDP contexts) for different types of traffic. For the predefined Standard connection package, ACA is disabled, but can be enabled. For new connection packages, ACA is disabled and cannot be enabled for shared connections.
- **Dedicated connection**, see *To set up dedicated connections on page 87*.
This is a connection dedicated specifically to each unit connected to the EXPLORER 710.

Connection packages

If you want to	Do as follows
Run one connection at a time from the startup page.	This is the default setup, with only one connection in each connection package. Start the connection you need from the web interface or the display.
Use different connection types for different types of traffic.	Add more connections to a connection package and apply filters to assign different connection types to different types of traffic. See <i>Multiple data connections on page 82</i> . Start all the connections in the package by starting the package from the web interface or the display.
Extend your bandwidth by connecting two EXPLORER 710 terminals (bonding).	Set up two EXPLORER 710 terminals as described in <i>To set up channel bonding on page 77</i> and <i>Bonding of terminals on page 33</i> . Start the bonding connection package from the web interface or the display (typically named 2 * <connection type>).

To change the contents of a connection package

You access the connection packages from the Dashboard.

- To access the Dashboard click  at the bottom of the page.
- To change the contents of a connection package, click  in the right side of the tile with the connection package.

If you want to	Do as follows
Change the name of the connection package	Click Properties , type in the new name and click Save . The new name is shown on the tile on the startup page.
Delete a connection package	Click Delete package ^a Note: You cannot delete Standard data .
Remove connections from the connection package	Click Connections and then click  in the tile with the connection you want to remove.
Add a connection to the package	See <i>Multiple data connections on page 82</i> .

a. If you accidentally delete a connection package, you can either create a new manually, or restore factory settings. Note, however, that all changes to the configuration will be lost if you restore factory settings.

To change the APN for a connection package

By default a connection package is set to use no IP Header compression and to use the APN (Access Point Name) from the SIM card. This is suitable for most applications.

Note It is recommended to leave **IP Header compression** disabled. This means that the data packets are transmitted more reliably with less data loss. However, you can select IP Header compression with the risk of less stability.

If you want to use a different APN, do as follows:

1. Click  in the right side of the tile with the connection package that you want to change.
2. Select **Parameters**.
3. Next to **APN**, select the source of the APN.
 - **SIM default** (default and recommended setting): The APN is taken from the SIM card.
 - **Network assigned**: The APN is assigned from the network.
 - **User defined**: APNs are provided from the Airtime Provider. Type in the APN next to **User defined name**.
4. If your APN uses a password, type in the **User name** and **Password** provided from the Airtime Provider.
5. Click **Save**.

Automatic Context Activation (ACA)

With ACA enabled, the terminal automatically establishes a data connection when it is registered on the satellite network.

Note

Different types of connection packages have different setup for ACA:

- For the predefined Standard (shared) connection package, ACA is disabled by default but can be enabled.
- For a new shared connection package, ACA is disabled and cannot be enabled.
- For a dedicated DHCP connection, ACA is enabled by default and cannot be disabled.
- For a dedicated static IP connection, ACA can be enabled or disabled.

To set up automatic activation of your data connection, do as follows:

1. Click  in the right side of the tile with the connection package that you want to change.
2. Select **Parameters**.
3. Select **Automatic Context Activation (ACA)**.
 - When you select **Automatic Context Activation (ACA)** and connect to the LAN or WLAN interface, the data connection is automatically established as soon as the EXPLORER 710 and its BGAN connection are ready.

Note

You are charged for the data transferred. You may want to disable automatic updates in your LAN or WLAN device to avoid unnecessary charges.

- When you **disable** automatic activation (default), you can control the data connection manually from the startup page.

Multiple data connections

If you want to have different types of connections running at the same time, you can build connection packages with the connections you want, using filters to determine which traffic should use which connection type.

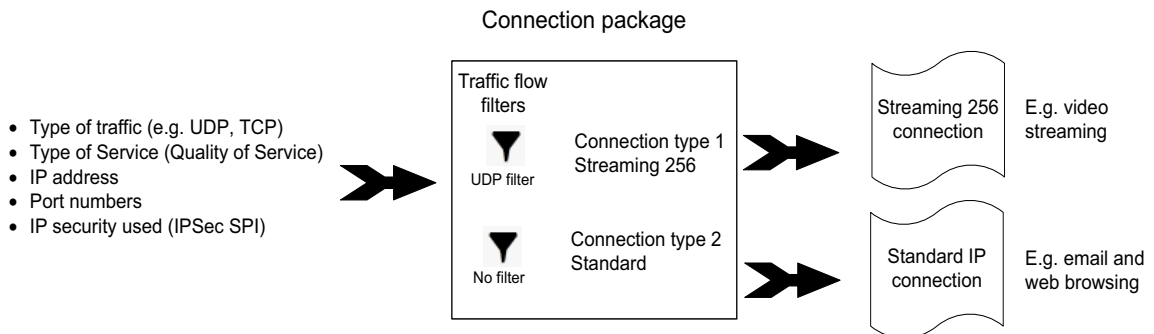

You then have to set up the following:

- Create a new package. See the next section *To create a shared connection package*.
- Add connections to the package and select a predefined filter for each connection.
- Optional: Change the APN for the package. See *To change the APN for a connection package on page 80*.

Example: You want to be able to send email while making a live video transmission with your EXPLORER 710:

You build a new package containing 2 connections:

1: A 256 kbps streaming connection (for your video transmission). Select the UDP filter.

2: A Standard connection (for email etc.). Select “No filter”.

When you have started this connection package, your video input to the EXPLORER 710 terminal is now automatically routed to the 256 kbps streaming connection. All other traffic is routed to the Standard data connection.

To create a shared connection package

1. From the startup page, click **New connection package**.

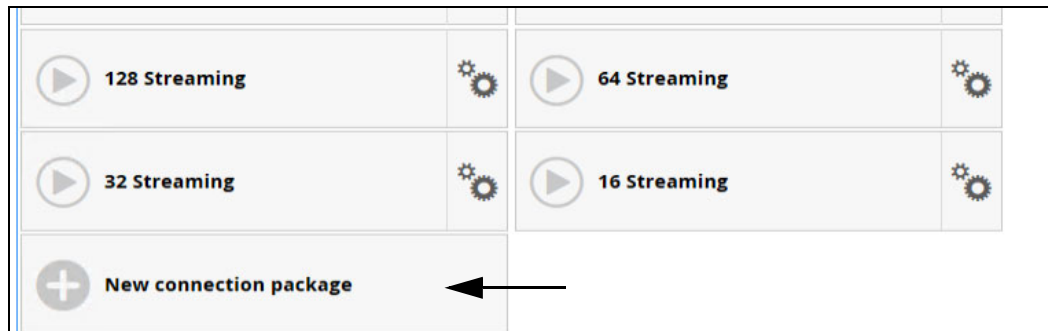

2. Type a **Name** for the new connection package.
3. Under **Type**, select **Shared connection**.
For Dedicated connections, see *To set up dedicated connections on page 87*.

 A screenshot of a web form titled 'EXPLORER 710 > Connection package'. The form has a blue header with the text 'Enter new values and click Save'. Below the header are three input fields: 'Name' with the value 'New package', 'Type' with a dropdown menu set to 'Shared connection', and 'Static IP address' which is empty. At the bottom of the form are two buttons: 'Cancel' (with a trash icon) and 'Save' (with a floppy disk icon).

4. Click **Save**
5. Click **Click here to create connections**.

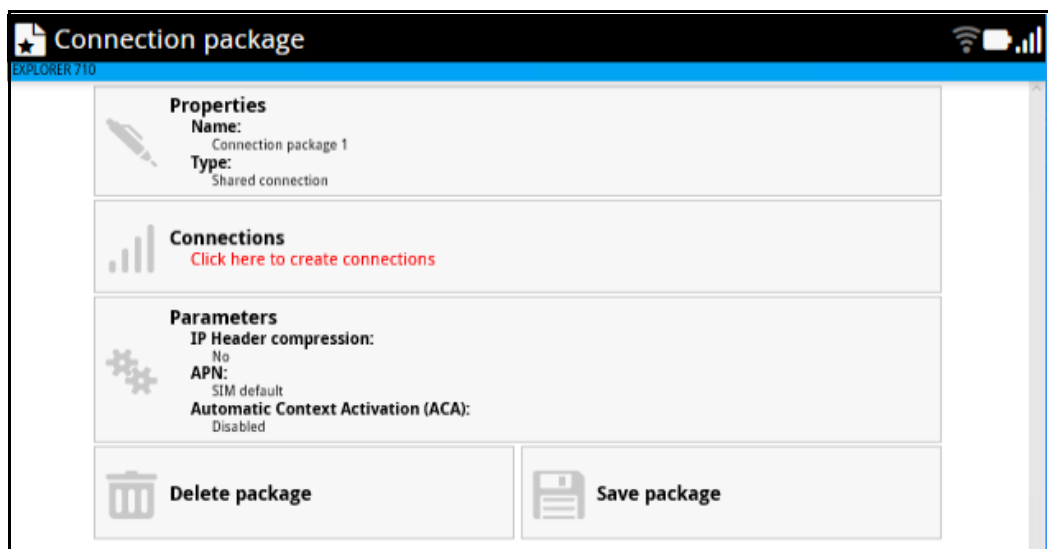

6. To add a connection to the connection package, click **Add connection** and select the type of connection you want to add.

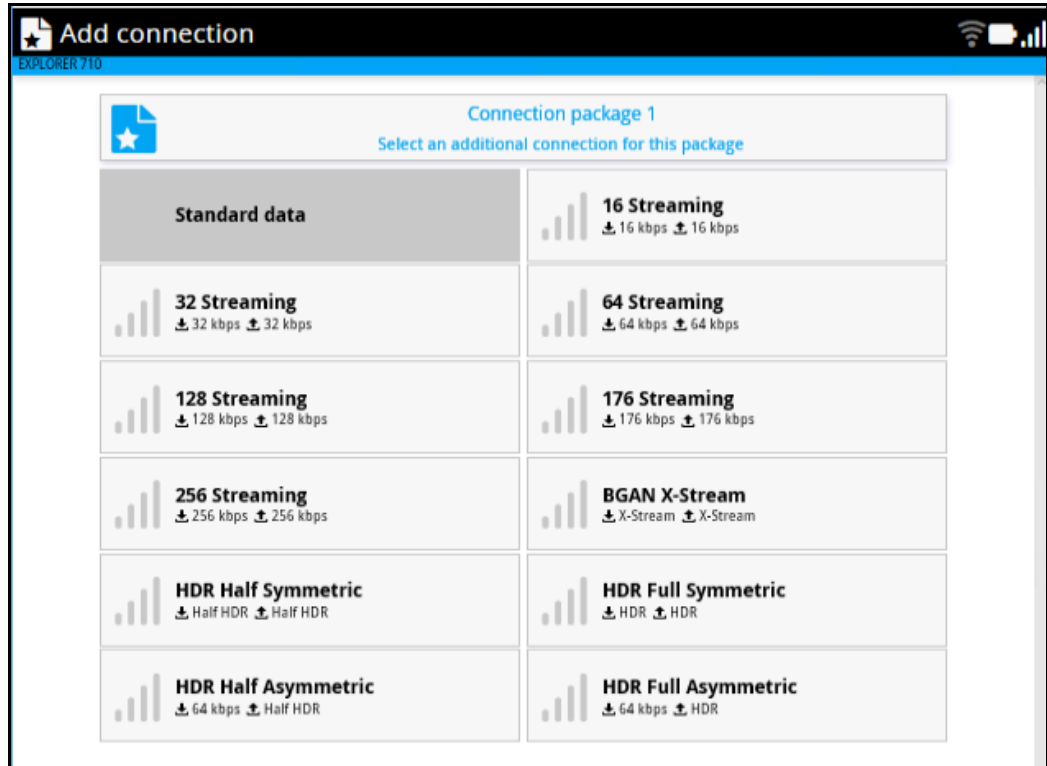

Important

You must select a filter for each connection. The filters are applied in the order they are added. This means that if you want to have a connection with no filter, it must be the last connection you add to your connection package. If not, the next filters are ignored, because “No filter” means all data passes through without filtering.

7. Select a predefined filter for your new connection.

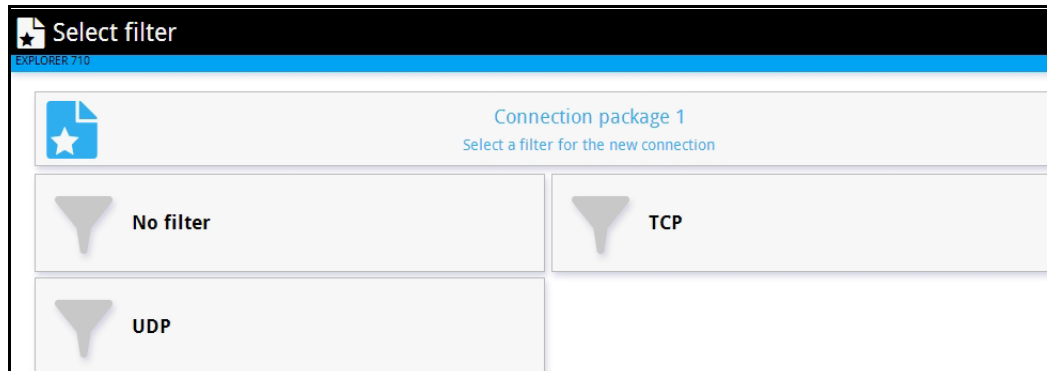

The predefined filters are:

- **UDP:** Filters traffic using UDP protocol (such as video streaming or Voice over IP).
- **TCP:** Filters Traffic using TCP protocol (such as web browsing)
- **No filter:** All data pass through. **Use only for the last connection** you add to your package.

The filters are applied in the order in which they were defined. This means that if you have a connection with no filter as the last connection, all traffic that does not match the first filters in the list will be passed through on this last connection. For this reason we recommend a Standard data connection for the “No filter” connection.

Note If you need a different filter than the ones available, you can log in as administrator and add new filters to the list. See *Traffic flow filter templates on page 105*.

The connection package now shows your first connection.

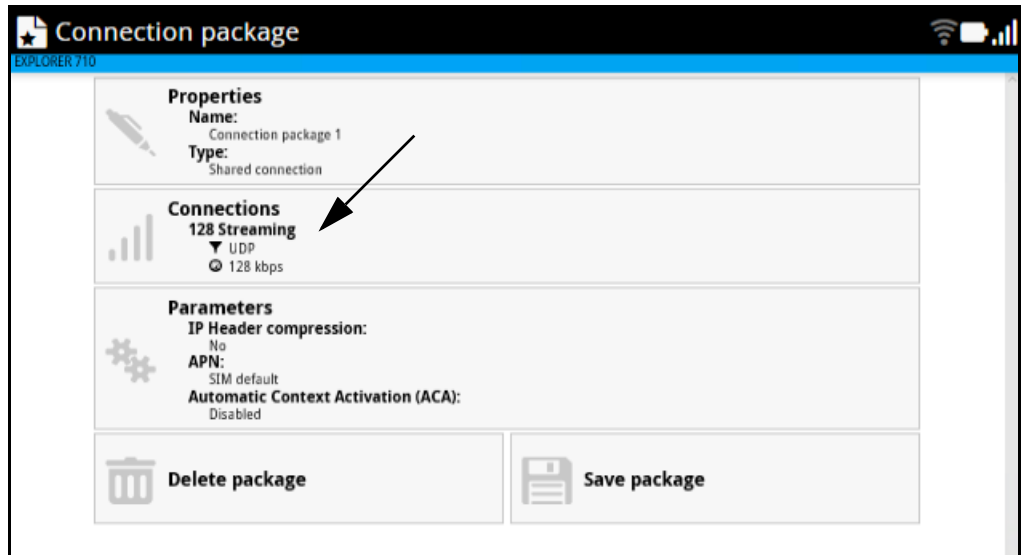

8. If you only want one connection in your package, click **Save package** and exit.
9. To add another connection to the same package, click the **Connections** tile again and click **Add connection**.
10. Select a connection type for your second connection.

Note You may not have all connection types available if you have selected a streaming type for your first connection, because your total bandwidth will be “filled up”.

11. Select a filter for the connection.
If this is the last connection in your connection package, you may select No filter, in order to let all remaining traffic use this connection
The connection package now contains the two connection types.

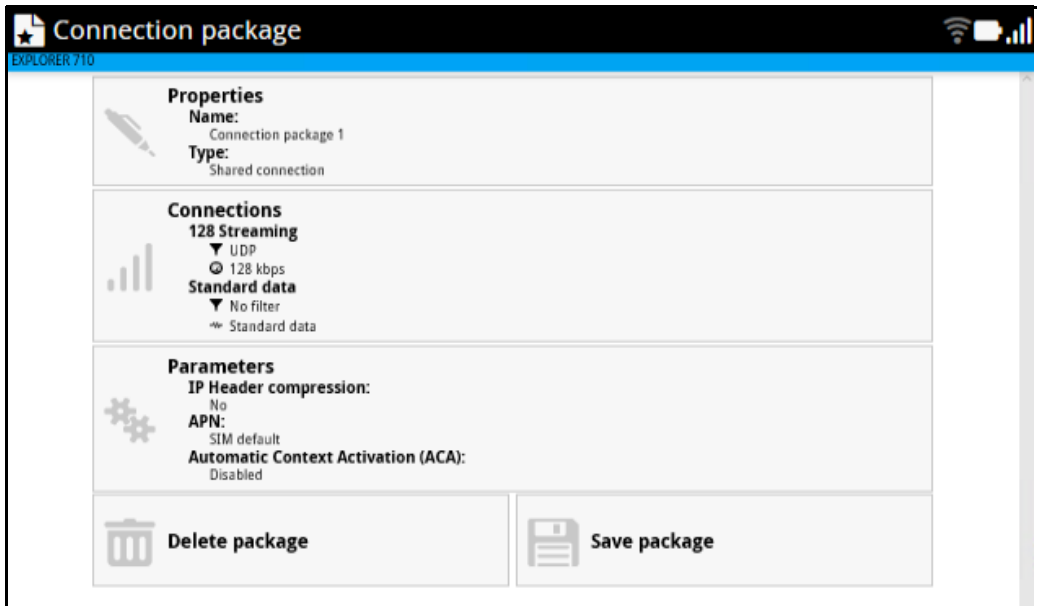

- 12. Click **Save package** when you have finished adding connections.
- The new connection package is now on the startup page.

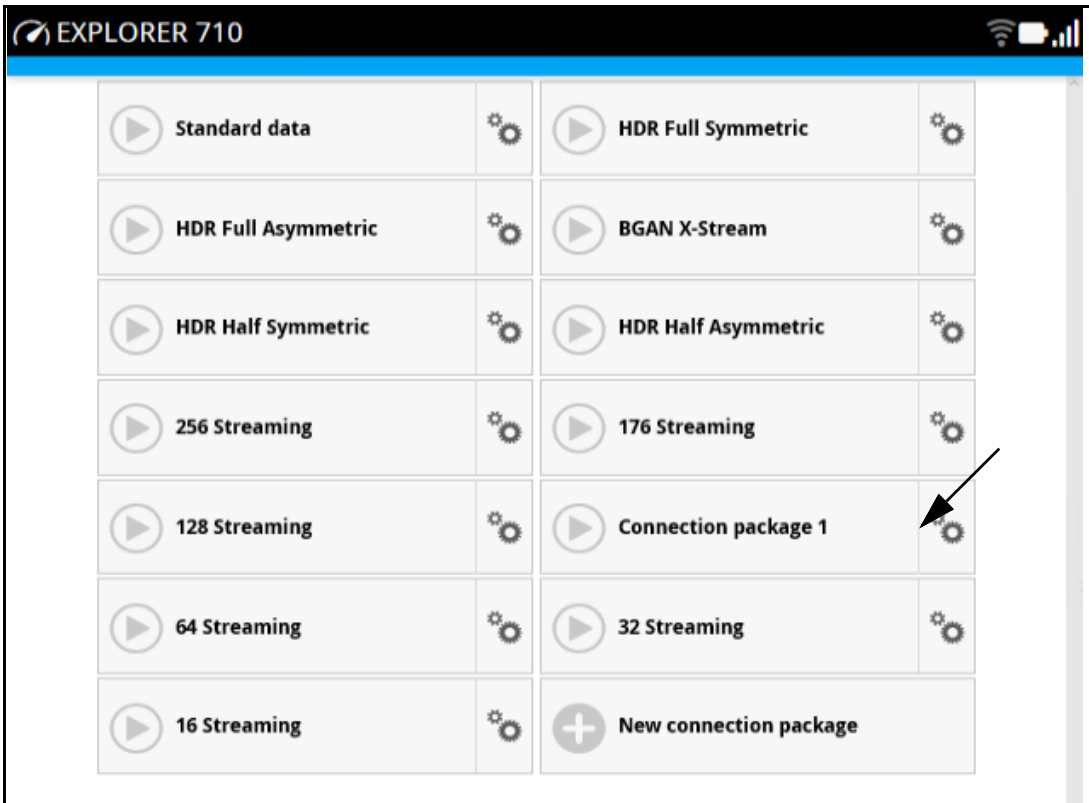

When traffic is detected on the LAN or WLAN interface, the filters are used to route the traffic. E.g. if you connect your video equipment with UDP traffic to the EXPLORER 710, your video transmission will use the connection that has UDP in the filter settings (128 Streaming in the example above).

To set up dedicated connections

You can set up dedicated connections for the EXPLORER 710.

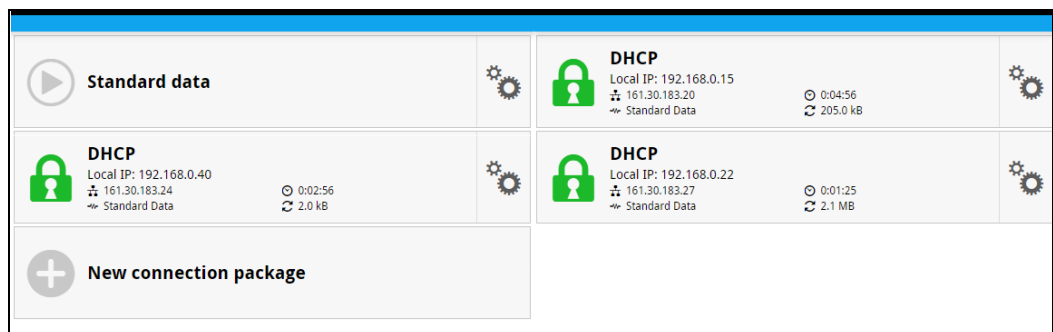

Note The terminal must be in BGAN mode in order to use dedicated connections. Under **Terminal settings > Connection > Mode** select **BGAN only**.

- From the **Dashboard**, click **New connection package** to create a new connection package, or click  in the right side of the tile with the connection package that you want to change and click **Properties**.
- Under **Type**, select one of the dedicated connection types.
 - Dedicated DHCP.** This is a dedicated connection using DHCP. With this type, any DHCP-enabled unit you connect to the EXPLORER 710 will get a new dedicated connection used only for that unit. When you disconnect the unit, the connection is removed after a few minutes. Each new connection gets its own tile on the Dashboard as long as it is running. In the example below, three units are connected using Dedicated DHCP. ACA is enabled for all Dedicated DHCP connections and cannot be disabled, unless you delete the connection package.



- Dedicated static IP.** This is a dedicated connection using a static IP address. Set up the connected unit to use a static IP address and type in this IP address under **Static IP address**.

Enter new values and click Save

Name	<input type="text" value="static"/>
Type	<input type="text" value="Dedicated static IP"/>
Static IP address	<input type="text" value="192.168.0.55"/>
 Cancel	 Save

If Automatic Context Activation (ACA) is enabled, the connection is established automatically. Only the unit with the configured static IP address can use this connection.

Note You can only start and stop a dedicated static IP connection by enabling and disabling ACA under **Parameters** or using SMS commands, see *Remote access with SMS* on page 37.

- Click **Save**.

To set up tracking and location reporting

You can set up the EXPLORER 710 to report to a server at certain time intervals. To set up tracking, do as follows:

1. From the Control panel , select **Tracking and location reporting**.

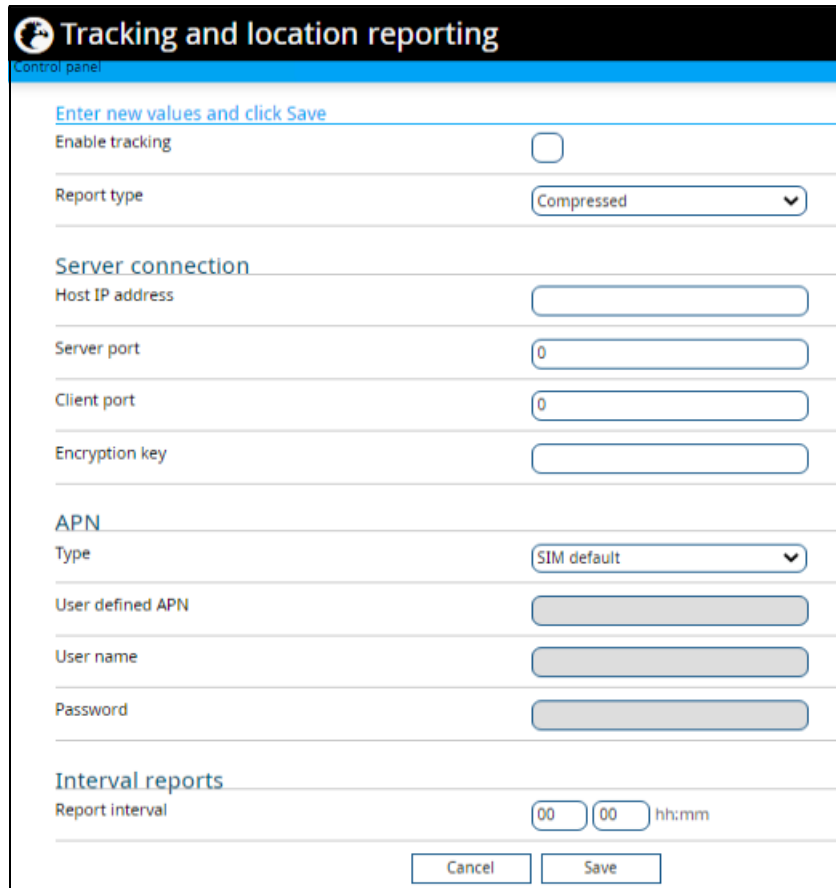

2. To enable tracking of the EXPLORER 710, select **Enable tracking**.

Note | HDR streaming is not available if you are using the Tracking function.

3. Select the **Report type**.
 - **Compressed**. Only latitude and longitude are reported.
 - **Extended**. Apart from latitude and longitude, heading and altitude are also included.
 - **ECEF**. The same information as Extended, but position and speed data are 3D (ECEF coordinates).
4. Under **Server connection**, type in the following details:
 - **Host IP address**: The IP address of the server that the EXPLORER 710 will report to.
 - **Server port**: Port number on the server. Default number is 7474.
 - **Client port**: Port number on the EXPLORER 710. Default number is 7475.
 - **Encryption key**: A supplied 128 bit key which must match on both the client and server side.
5. Under **APN**, select the source of the APN.

- **SIM default** (recommended): The APN is taken from the SIM card.
 - **Network assigned**: The APN is assigned from the network.
 - **User defined**: APNs are provided from the Airtime Provider. Type in the APN next to **User defined name**.
6. If required, type in the user name and password of the APN.
 7. Type in the **Report interval** in hours (h) and minutes (m).
Example: If you type in 1 h 30 m, the EXPLORER 710 will send a report for every 1½ hour.
 8. Click **Save**.

You can see the status of the tracking link in the status area of the web interface. If the status area is not shown, click  to see it.

Note

You can set up whether or not you want to allow the tracking server to control these settings. See *Remote control of tracking on page 103*.

Advanced LAN

Port forwarding

Note | Make the port forwarding configuration before starting the data session.

Port forwarding enables you to set up a server connected to the terminal while the terminal is in Router mode. Without port forwarding it would not be possible to contact the server from the Internet. We recommend using a static public IP address for the terminal in order to provide easy access to the terminal. To use the static IP address, it must be included in your subscription and you must set the APN source to SIM default. For details, see *To change the APN for a connection package on page 80*.

The following example shows how to allow Internet access to a mail server (smtp) connected to the terminal.

The mail server in this example has the IP address 192.168.0.100.

1. From the **Control panel** , select **Advanced LAN > Port forwarding**.
2. Select **Forward port** to add a new port forwarding.
3. Select **Active** to activate the port forwarding.
4. Type in the **Incoming port start** and the **Incoming port end**.
This is the range of port numbers on the EXPLORER 710 for which incoming traffic to the EXPLORER 710 will be forwarded.
5. Type in the **Destination IP address**, which in this example is the IP address of the mail server: 192.168.0.100.
This is the IP address to which the incoming traffic is forwarded.
6. Type in the **Destination port start** and the **Destination port end**.
This is the range of port numbers, in this example on the mail server, to which the incoming traffic will be forwarded.
7. Click **Save**.

When you have activated a data connection, you can now access the mail server from the Internet, using the external IP address of the terminal. You can see the external IP address in the tile with the data connection you have started. For information on how to activate your data connection, see *To start and stop data connections on page 55*.

Static routing

When you have an external gateway connected to your terminal, the terminal is not automatically able to “see” the network on the other side of the gateway. However, you can set up your terminal to communicate with a device on the other side of a gateway, by using Static routing. To set up a new device for static routing, do as follows:

1. From the **Control panel** , select **Advanced LAN > Static routing**.
2. Click **Add route**.
3. Enter the values for your device.
 - **Destination:** The IP address you want to route to.
 - **Subnet mask:** The subnet mask you want to route to.
 - **Gateway:** The gateway, e.g. the address of a wireless access point or router to which the destination device is connected.
4. Click **Save**.

The values for the new entry are now in the list. This means that the terminal can communicate with the destination IP address on the other side of the gateway.

To change the APN for PPPoE

What is PPPoE

By using PPPoE, users can virtually “dial” from one machine to another over an Ethernet network, establish a point to point connection between them and then securely transport data packets over the connection.

On the equipment connected to the EXPLORER 710 you must enter a few settings for your PPPoE connection. For example you need to set up which service to use (e.g. 64 kbps Streaming) and possibly a user name and password. For details, refer to the documentation for your connected equipment.

On the EXPLORER 710 you must set up the APN to use before you can establish a PPPoE connection.

1. From the **Control panel** , select **Advanced LAN > PPPoE APN**.
2. Select the **APN** to use for PPPoE. You have the following options:
 - **SIM default.** The APN is taken from the SIM card. This is the recommended option, unless you have special requirements.
 - **Network assigned.** The APN is assigned from the network.
 - **User defined.** Type in the APN at **User defined name**. APNs are provided from the Airtime Provider.
3. Click **Save**.

Advanced settings

First time use

The first time you access the EXPLORER 710 web interface the administrator password is disabled, so you have access to all settings. If you want to use an administrator password, you can enable it as described in the next section.

Administrator password

To enable the administrator password

If the administrator password is disabled and you want to protect the advanced settings with a password, do as follows:

1. From the Control panel , select **Advanced**.
2. Select **Passwords > Enable administrator password**.
3. Type in the administrator password you want to use.
4. Repeat the new password on the next line.
5. Click **Save**.

To disable the administrator password

If you want to disable the administrator password, do as follows:

1. From the Control panel , select **Advanced**.
2. If you are not already logged in, enter the administrator password and click **Login**. The default password is **admin**.
3. Select **Passwords > Disable administrator password**.
All settings are now available without password protection.

To log in

If the administrator password is enabled, the Advanced settings require an administrator password. To log in as administrator, do as follows:

1. From the Control panel , select **Advanced**.
If you are not logged in as administrator you are now prompted to log in.
2. Enter the Administrator password. If you have forgotten the administrator password, you can reset the password. For details, see *To reset the administrator password on page 72*. The old user name and password will apply until you have finished the reset procedure.
3. Click **Login**.

To change the administrator password

To change the administrator password, do as follows:

1. Log in as administrator
2. Under **Advanced**, select **Passwords > Change administrator password**.
3. Type in the **Old password**.
4. Type in the **New password** and retype it on the next line.
5. Click **Save**.
At the next login the new password is required.

To log out as administrator

If you have not entered anything for 30 minutes under **Advanced**, you are logged out automatically. To log out manually, click **Logout administrator** in the **Advanced** page or click [log out] next to administrator in the **Terminal status** field.

To set up user permissions

You can allow or deny users access to certain functions and make these pages read-only. This is useful if you want to protect the system against unintended changes. Study this screen thoroughly and decide to which areas of the system you want to give non-administrator users access. To set up the user permissions, do as follows:

1. Under **Advanced**, select **User permissions**.
2. Under **Allow users to:**, select the settings you want to **allow** users to access.

Note

If you remove the check mark at one of the interface settings (LAN, WLAN etc.), it will not be possible to enable/disable the interface from the display.

3. Under **Allow user accounts:**, select **Service user account** if you want to enable the use of a service user account.
4. Click **Save**.

The settings without a check mark can only be viewed but not changed by the non-administrator user.

To restore factory settings

To restore the factory settings of the EXPLORER 710, do as follows:

1. Under **Advanced**, select **Factory reset**.

Important

All configuration will be lost and the EXPLORER 710 will return to the default configuration.

2. Click **OK**.
The terminal will now restart and start up with the factory settings.

SIM PIN for BGAN

To enable or disable the use of a SIM PIN

To enable or disable the use of a PIN to access the BGAN network, do as follows:

1. Under **Advanced**, select **SIM**.
2. Select **Enable/disable SIM PIN**.
3. Under **Enable/Disable PIN** select or clear the box next to **Require PIN on startup**.
 - If you clear the box, you can access and use the terminal without entering a PIN
 - If you select the box, you must enter a PIN on startup before you can make calls or data sessions
4. If you selected **Require PIN on startup**, type in the PIN next to **Enter current PIN**.
5. Click **Save**.
The new PIN settings will take effect at next power on.

To change the SIM PIN

To change the PIN used to access the BGAN network, do as follows:

1. Under **Advanced**, select **SIM**.
2. Select **Change SIM PIN**.
3. Under **Change PIN** type in the **Current PIN**.
4. Type in the **New PIN** and retype it on the next line.
5. Click **Save**. The new PIN settings will take effect at next power on.

SIM lock

The SIM lock feature can be used by suppliers to lock your SIM card to a specific provider or distribution partner. For further information, contact your supplier.

SIM PIN for cellular network (optional)

Note

The SIM settings for cellular network are only available when the EXPLORER Cellular Modem is inserted.

To enable or disable the use of a cellular SIM PIN

To enable or disable the use of a PIN to access the cellular network, do as follows:

1. Under **Advanced**, select **EXPLORER Cellular Modem**.
2. Select **Enable/disable SIM PIN**.
3. Under **Enable/Disable PIN** select or clear the box next to **Require PIN on startup**.
 - If you clear the box, you can access and use the terminal without entering a PIN
 - If you select the box, you must enter a PIN on startup before you can make calls or data sessions
4. If you selected Require PIN on startup, type in the PIN next to **Enter current PIN**.
5. Click **Save**.
The new PIN settings will take effect at next power on.

To change the cellular SIM PIN

To change the PIN used to access the cellular network, do as follows:

1. Under **Advanced**, select **EXPLORER Cellular Modem**.
2. Select **Change SIM PIN**.
3. Under **Change PIN** type in the **Current PIN**.
4. Type in the **New PIN** and retype it on the next line.
5. Click **Save**. The new PIN settings will take effect at next power on.

To save or load a configuration

If you need to reuse a configuration in another terminal of the same type and software version, you can save your current configuration to a file, which can then be loaded into the other terminal.

Note

Configuration files can only be exchanged between terminals with the same software version!

To save a configuration to a file

To save the current configuration of your terminal to a file on your computer, do as follows:

1. In the **Advanced** page, click **Load/save configuration**.
2. Click **Save configuration**. The configuration file is saved in the EXPLORER 710.
3. Click **Download configuration...**
The configuration is downloaded from the EXPLORER 710 to the downloads section of your computer.

To load a configuration from a file

To load a configuration from a file into your EXPLORER 710, do as follows:

1. In the **Advanced** page, click **Load/save configuration**.
2. Click **Load configuration**.
3. Browse to the configuration file and click **Open...**
The configuration is now loaded into your EXPLORER 710. When the configuration is loaded successfully, the EXPLORER 710 restarts with the new configuration.

Connection watchdog (Link monitoring)

If you are **not** using the Terminal watchdog function (see *Terminal watchdog on page 97*), you can monitor the external IP connection of the EXPLORER 710 system using the Connection watchdog. With this feature activated, the terminal will send out ping commands (ICMP Echo Requests) to up to three servers of your choice.

Function of Connection watchdog

With the connection watchdog activated, the terminal will send out ping commands to up to three servers of your choice. When a data session is started, the terminal will start sending ping commands to the Primary IP address the number of times specified. If no response is received, it will send the same number of ping commands to the Secondary and then the Tertiary IP

address, if available. If no response is received from any of the IP addresses, the terminal will first try to reconnect. If it fails again the terminal will eventually restart.

Note Ping commands are sent on all active data connections. For the Connection watchdog to work, the data connection must be (re)started after enabling the Connection Watchdog. If ACA is enabled, the data connection is restarted automatically. See *Automatic Context Activation (ACA) on page 81*.

To set up the Connection watchdog

To set up the Connection watchdog, do as follows:

1. Under **Advanced**, select **Connection watchdog**.
2. Select **Enable Connection watchdog**.
3. At **Ping interval (minutes)** select the Interval in minutes between the ping commands.
4. Select the **Number of retries** before the terminal restarts.
5. Type in the Primary and optionally the Secondary and Tertiary IP address. This is the IP address of the server(s) to which the terminal will send ping commands.

Note Use a server that is reliable and that responds to ICMP Echo Requests.

6. Click **Save**.

Terminal watchdog

The Terminal watchdog continuously monitors the operational status of the terminal and allows you to perform the following actions at regular intervals (set by the user):

- Start a data connection (PDP context)
- Verify your data connection (ping - similar to Connection watchdog)

The terminal continuously monitors:

- The time (monitors that UTC time is received from GPS at startup)

Note The EXPLORER 710 operates with UTC time, local time is not available.

- CS-attach (the status of the circuit-switched connection)

If any of the actions fail, the terminal restarts.

Set up Terminal watchdog

To set up the Terminal watchdog, do as follows:

1. Under **Advanced**, select **Terminal watchdog**.

2. Select **Enable watchdog**.
 3. Select the **Watchdog interval**.
The interval can be from one hour up to 21 days.
 4. Type in the **Primary** and optionally the **Secondary** and **Tertiary IP address**.
This is the IP address(es) of the server(s) to which the terminal will send ping commands. The terminal will start sending ping commands to the Primary IP address. If there is no response after 10 attempts, the terminal will send up to 10 ping commands to the Secondary and then the Tertiary IP address, if available. If no response is received from any of the IP addresses, the terminal will eventually restart.
- Note** | If no IP addresses are entered, pinging is skipped but the other actions still apply.
5. Enter the **APN** (and user name and password if required) to use for the data connection.
 6. Select **Enable position SMS** and enter the phone number, if you want the terminal to send SMSes with the position of the terminal to a phone number. The SMSes will be sent with the Watchdog interval from step 3.
 7. Select **Enable loopback SMS** and enter the phone number of the terminal, if you want the terminal to send SMSes to itself in order to check the SMS function. The SMSes will be sent with the Watchdog interval from step 3.
 8. Click **Save**.

Note | When the Terminal watchdog is enabled, you must reboot the terminal before the Watchdog settings are activated.

Next run time: This field at the bottom of the page shows what time the Terminal watchdog will run next (UTC time).

Data limits

You can set a limit for the use of BGAN data services with the EXPLORER 710 system.

If you have entered the BGAN call charges in the menu **Call charges**, the system automatically calculates and displays the maximum charges for your BGAN data sessions.

Note Thrane & Thrane A/S does not take responsibility for the correctness of the estimated charges. This calculation is only a rough estimate of the charge, based on the tariff entered by the user. Also, the airtime provider may have different methods of calculating the charge.

Once the entered limit is reached, the connection is automatically stopped. This is recorded in the data log. To continue using the data service you must start a new connection by clicking on the desired connection on the startup page.

Note If you have enabled automatic activation of the Standard data connection and you set a data limit for the Standard data connection, automatic activation is disabled.

To set data limits, do as follows:

1. Under **Advanced**, select **Data limits**.
2. Select the type of connection you want to limit.
3. Type in the amount of data or time allowed and select the appropriate units.
4. Select **Enable**.
5. Click **Save** to save the settings.

Call charges

Note Thrane & Thrane A/S does not take responsibility for the correctness of the estimated charges. This calculation is only a rough estimate of the charge, based on the tariff entered by the user. Also, the Airtime Provider may have different methods of measuring the airtime used.

If you know the tariff for your subscribed BGAN services, you can enter these tariffs in the web interface and automatically calculate the estimated charges for your BGAN calls and data sessions. To enter the call tariffs, do as follows:

1. Under **Advanced**, select **Call Charges**.
2. Select the currency from the **Displayed currency** drop-down list.
3. Enter the tariff for each of the BGAN services.
4. Click **Save**.

The entered tariffs are used for estimating the charges for calls and data sessions over the BGAN network. For further information, see *Call log on page 61*.

Prepare the terminal for remote management

You can set up the terminal so that it can be controlled from a remote location.

To set up the terminal for remote management, select **Advanced > Remote management** from the **Control panel**.

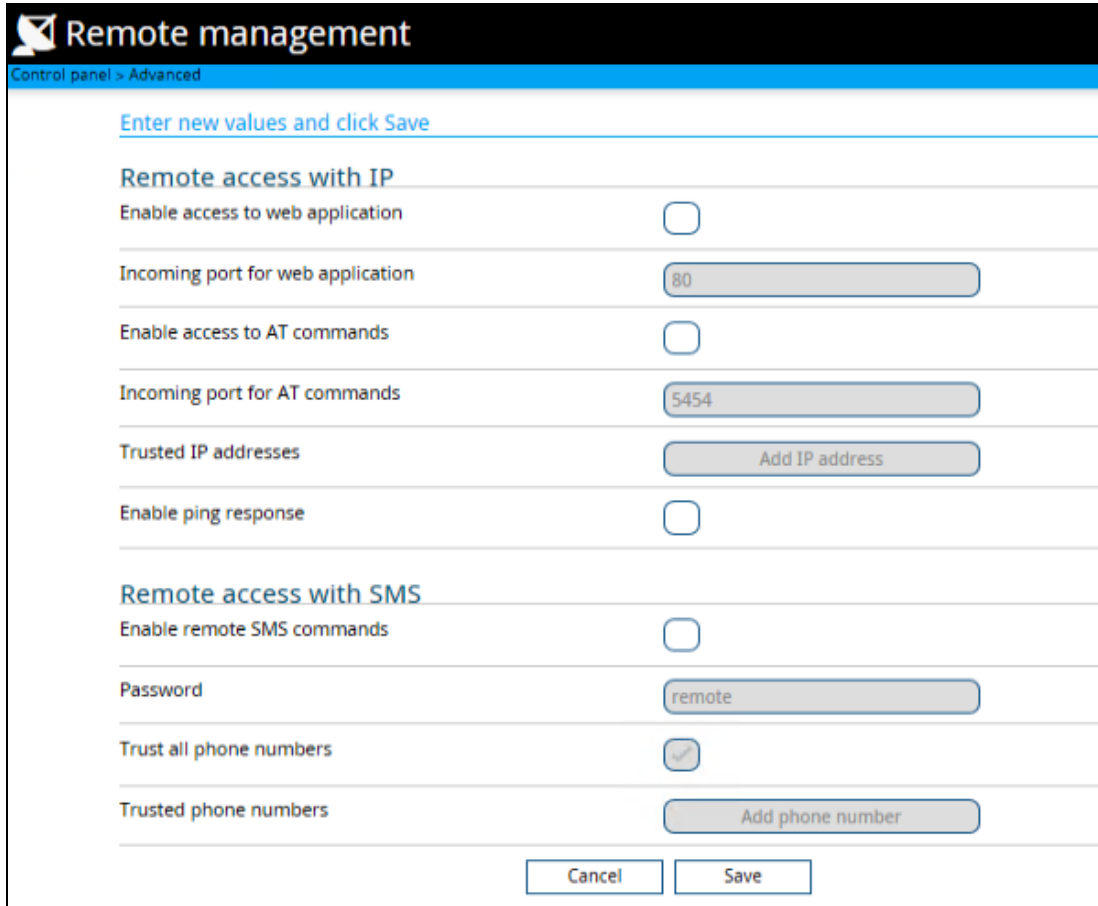

The screenshot shows the 'Remote management' configuration page in a web interface. The page title is 'Remote management' and the breadcrumb is 'Control panel > Advanced'. A blue banner at the top says 'Enter new values and click Save'. The page is divided into two main sections: 'Remote access with IP' and 'Remote access with SMS'. Each section contains several settings with checkboxes and input fields.

Section	Setting	Value / State
Remote access with IP	Enable access to web application	<input type="checkbox"/>
	Incoming port for web application	80
	Enable access to AT commands	<input type="checkbox"/>
	Incoming port for AT commands	5454
	Trusted IP addresses	Add IP address
	Enable ping response	<input type="checkbox"/>
Remote access with SMS	Enable remote SMS commands	<input type="checkbox"/>
	Password	remote
	Trust all phone numbers	<input checked="" type="checkbox"/>
	Trusted phone numbers	Add phone number

At the bottom of the form are two buttons: 'Cancel' and 'Save'.

Prepare the terminal for remote access with IP

Note

The settings for Remote access with IP are **not** relevant if you are using the SMS ATCO command **_IREMWEB** to get access to the web interface from a remote location, or you only need remote access by SMS commands.

For details on SMS commands, see the next section and *Remote access with SMS on page 37*. For details on how to use the **_IREMWEB** command, see *To use AT commands to get remote access to the web interface on page 39*.

1. From the **Remote management** page, locate the section **Remote access with IP**.
2. Select **Enable access to web application** and/or **Enable access to AT commands**.
3. Type in the **Incoming port** numbers to use for the web server and for AT commands. The default port numbers are:
 - web server: 80
 - AT commands: 5454

Note

If you type another port number, the port number must be available at your service provider.

4. Under **Trusted IP addresses**, click **Add IP address** and type in the IP address of the device you want to give access to the terminal.
5. To add more IP addresses, click **Add IP address** again.
6. Select **Enable ping response** if you want to enable the terminal to respond to ping commands.

Note

To be able to access the terminal you must have an active data connection.

After preparing the terminal and activating the connection you can access the terminal from one of the trusted IP addresses, using the incoming port defined in the Incoming port field.

For information on how to access the terminal, see *To get remote access from a trusted IP address (preconfigured) on page 40*.

If Static IP is included in your airtime subscription, we recommend using this static public IP address for the terminal in order to provide easy access to the terminal. To use the static IP address, it must be included in your airtime subscription and you must set the APN source to SIM default. For details, see *To change the APN for a connection package on page 80*.

Prepare the terminal for remote access with SMS

Note The terminal must be logged on to the BGAN satellite services to receive and accept an SMS.

1. From the **Remote management** page, locate the section **Remote access with SMS**.
2. Select whether you want to **Enable remote SMS commands**.
3. Enter the password for remote SMS. It can be 5 to 15 characters long. The characters 0-9, a-z and A-Z are allowed. **The password is mandatory**. This password must be entered every time you send an SMS command. Default password is **remote**.
See *Remote access with SMS on page 37*.
4. Select **Trust all phone numbers** or, at **Trusted phone numbers**, enter at least one trusted mobile number from which the terminal accepts an SMS. Use the wild card * to accept a range of trusted numbers.

Entered mobile number with wild card	Mobile numbers accepted
+453955880*	+4539558800 to +4539558809
+45395588*	+4539558800 to +4539558899

Important If you select **Trust all phone numbers** you should take security measures such as changing the SMS remote password in order to avoid unintended use.

5. To add more phone numbers, click **Add phone number** again.
6. Click **Save**.

For information on how to send SMS commands, see *Remote access with SMS on page 37*.

Remote control of tracking

When you are using the tracking function of the EXPLORER 710, you can set up the terminal so that the tracking server can access the EXPLORER 710 e.g. to start or stop tracking or to change reporting intervals.

To allow the tracking server to control the tracking settings, do as follows:

1. Under **Advanced**, select **Tracking settings**.
2. Select **Allow remote control of tracking**.
3. Click **Save**.

The EXPLORER terminal will now accept commands from the specified tracking server, for example to change reporting intervals or start/stop reporting.

To configure data connection types and filters

If the default connection types and filters do not meet your requirements, you can build new templates for the connection types and/or traffic flow filters to match your needs.

Connection templates

To access the connection templates, do as follows:

1. Under **Advanced**, select **Templates**.
2. Select **Connections**.
3. To delete a connection type, click  in the right side of the connection type.
4. To add a new connection type, click **Add template** and proceed with the next steps.

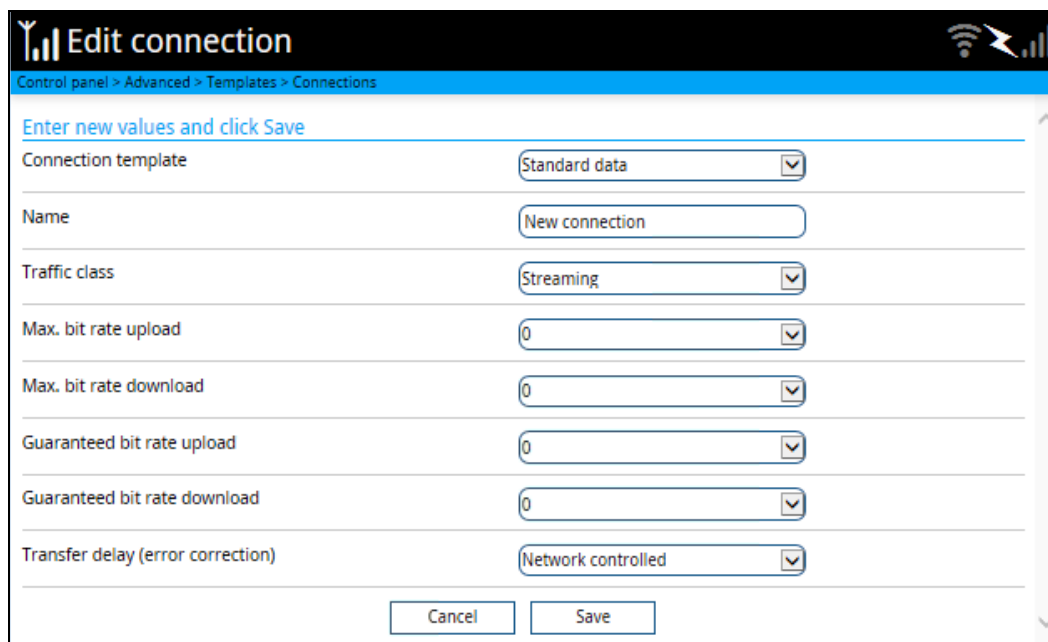

5. Select an existing **Connection template** as a basis for your new template.
6. Type in a suitable **Name** for the connection type.
7. Select the **Traffic class**.
 - **Standard** is a shared, best-effort connection, used e.g. for email or Internet browsing.
 - **Streaming** is an exclusive, high-priority connection with a guaranteed bit rate.
8. Select the following bit rates:
 - **Max. bit rate upload** is the maximum upload bit rate allowed for this connection type.
 - **Max. bit rate download** is the maximum download bit rate allowed for this connection type.
 - **Guaranteed bit rate upload**: For normal Streaming services (e.g. Streaming 128) this is the guaranteed upload bit rate needed for this connection type. For HDR and BGAN X-Stream services, this bit rate is only an indicator for which service is used, it is NOT a guaranteed bit rate.

- **Guaranteed bit rate download:** For normal Streaming services (e.g. Streaming 128) this is the guaranteed download bit rate needed for this connection type. For HDR and BGAN X-Stream services, this bit rate is only an indicator for which service is used, it is NOT a guaranteed bit rate.
9. In the **Transfer delay (error correction)** field, select **Enabled**, **Disabled** or **Network controlled**.
 - Enabled: Error correction is applied
 - Disabled: Error correction is disabled (recommended for time critical applications)
 - Network controlled: Error correction determined by network
 10. Click **Save**.

The new template will now be available for selection when you build your connection packages.

Traffic flow filter templates

Note | Traffic flow filters are only for shared connections, **not** for dedicated connections.

The traffic flow filters are used to filter the data traffic, so you can use different connection types for different types of traffic. There are two predefined filters, UDP and TCP.

- **UDP** is used for traffic using UDP protocol (such as video streaming or Voice over IP)
- **TCP** is used for traffic using TCP protocol (such as web browsing).

You can also select **No filter**. This option is only suitable for the last connection you add to a connection package, because the filters are applied in the order they are added to the connection package. See *Multiple data connections on page 82*.

If the predefined filters do not meet your requirements, you can create additional filter templates. Do as follows:

1. Under **Advanced**, select **Templates**.
2. Select **Traffic flow filters**.

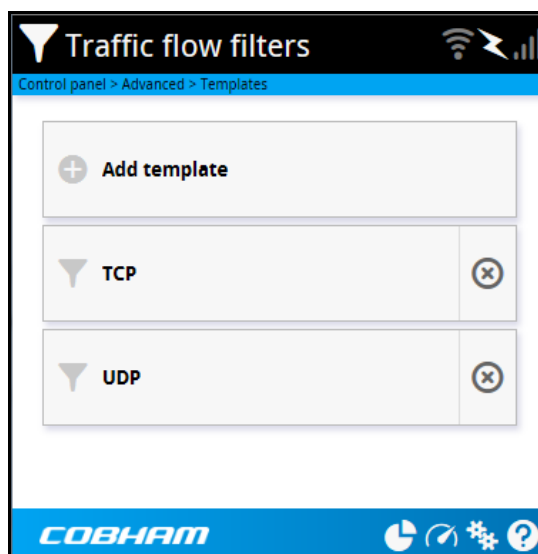

3. To delete a traffic flow filter, click  in the right side of the filter tile.
4. To add a new traffic flow filter, click **Add template** and proceed with the next steps.

▼ Edit filter

Control panel > Advanced > Templates > Traffic flow filters

Enter new values and click Save

Name	<input style="width: 90%;" type="text" value="New filter"/>
Use global IP filter	<input type="checkbox"/>
Global IP address	<input style="width: 90%;" type="text"/>
Subnet mask	<input style="width: 90%;" type="text" value="255.255.255.255"/>
Use protocol number filter	<input type="checkbox"/>
Protocol number	<input style="border: 1px solid #ccc; border-radius: 2px; background-color: #f0f0f0;" type="text" value="User defined"/> ▼
	<input style="width: 90%;" type="text"/>
Use local port filter	<input type="checkbox"/>
Port start	<input style="width: 90%;" type="text"/>
Port end	<input style="width: 90%;" type="text"/>
Use global port filter	<input type="checkbox"/>
Port start	<input style="width: 90%;" type="text"/>
Port end	<input style="width: 90%;" type="text"/>
Use type of service filter	<input type="checkbox"/>
Type of service	<input style="width: 90%;" type="text"/>
Type of service mask	<input style="width: 90%;" type="text"/>
Use IPsec SPI filter	<input type="checkbox"/>
IPsec Security Parameter Index (hex)	<input style="width: 90%;" type="text"/>

5. Type in a suitable name for the filter.
6. Select the item(s) you want to use for filtering and enter the details for the item(s). You can select one or more of the following items:
 - Use global IP filter.
Traffic to and from the IP address or network (subnet mask) entered here is automatically routed to the connection type associated with this traffic flow filter.
 - Use protocol number filter.
This is the type of protocol that is used for the data traffic. E.g. if this is set to 17 (UDP),

the filter will automatically route UDP data traffic to the connection type associated with this traffic flow filter.

- Use local port filter.
This is a range of local port numbers on the terminal. The filter will route traffic to and from any of these port numbers to the connection type associated with this traffic flow filter.
- Use global port filter.
This is a range of global port numbers on the terminal. The filter will route traffic to and from any of these port numbers to the connection type associated with this traffic flow filter.
- Use type of service filter.
Type of Service (TOS) is used to define the Quality of Service. Set this value to a number between 0 and 255. The filter will route traffic with this Quality of Service to the connection type associated with this traffic flow filter.
- Use IPsec SPI filter.
IP security. The filter will route traffic using the Security Parameter Index (SPI) stated here (in hexadecimal numbers) to the connection type associated with this traffic flow filter.

7. Click **Save**.

The new filter will now be available for selection when you add new connections to a connection package. Note that you can only select one filter per connection.

Example: You want a connection package, which allows you to use uninterrupted Voice over IP while having a Standard data connection for web browsing etc. Do as follows:

1. Create a filter template with
 - Protocol=UDP (Use protocol number filter)
 - Type of Service = 0xb8 and Type of Service mask = 255 (Use type of service filter)

The UDP protocol is suitable for UDP voice streaming and the TOS value 0xb8 is used by some linksys Voice over IP adapters.
2. Create a connection package as described in *Multiple data connections on page 82*.
3. Add a connection, e.g. **Streaming 32** with the new filter you created in step 1.
4. Add a Standard connection with **No filter**.

Help desk

Under Help desk you can enter the contact information you want for your EXPLORER 710. The Help desk contact information is empty by default. You must provide the contact information, e.g. the phone number for your Airtime Provider. Do as follows:

1. In the **Advanced** page, select **Help desk**.
2. Type in the contact information you want.
3. select **Save**.

The Help desk information is now available from the About page ( (Control panel) > **Support > About**).

Security

To enable the use of Thrane IP Handset

1. From the **Advanced** page select **Security**.

2. Locate the field **Thrane IP Handset support**.
3. If you want the terminal to support BGAN profile and menu in Thrane IP Handsets, select **Support BGAN profile and menu in Thrane IP Handsets**.
This means that, in addition to making calls with the Thrane IP handset over the BGAN network, you can use the handset display and keypad to:
 - Enter PIN/PUK for the terminal.
 - View pending alarms.
 - View event log.
 - View current satellite status and signal strength.
 - Start/stop connection packages.

For details, see the user manual for the Thrane IP Handset.

To allow or block the use of AT commands on LAN/WLAN interface

AT commands are low-level commands used to control modems, in this case the EXPLORER 710. They are typically used during service and maintenance or when troubleshooting the terminal.

1. Under **Advanced > Security**, locate the field **AT commands**.
2. If you want to block the use of AT commands, remove the check mark at **Allow on LAN/WLAN interface** (default allowed).

3. If you want users to enter a password to be able to use AT commands on the LAN/WLAN interface, select **Require password**. This means that users must enter a password using the `_ICLCK` command before they can send AT commands on the LAN/WLAN interface. By default, no password is required in order to send AT commands on the LAN/WLAN interface.

Important

Before you select this option, make sure you know the administrator password of the EXPLORER 710! The default password is **admin**.

4. Click **Save**.

HTTPS settings

The EXPLORER 710 internal web server supports HTTPS, which includes encryption of the exchanged web traffic when accessing the EXPLORER 710 web interface.

By default, the system uses a self-signed certificate, but it also allows you to upload your own certificate signed by a trusted Certificate Authority.

Note

If you redirect traffic to HTTPS, you **cannot connect** to the EXPLORER 710 with the **EXPLORER Connect app**.

Do as follows:

1. Under **Advanced > Security**, locate the field **HTTPS**.
2. Select **Redirect HTTP to HTTPS** if you want the EXPLORER 710 to automatically redirect your HTTP traffic to HTTPS.
3. Select **Use uploaded TLS/SSL certificate** and click **Upload certificate** if you want to upload your own generated SSL certificate for the system to use. Please note that the uploaded certificate file (.pem file format) must include the RSA private key used to generate the certificate:

```
-----BEGIN CERTIFICATE-----
...
... <your certificate here> ...
...
-----END CERTIFICATE-----
-----BEGIN RSA PRIVATE KEY-----
...
... <your key here> ...
...
-----END RSA PRIVATE KEY-----
```

4. Click **Save**.

Optional: To set up cellular network for data

The EXPLORER 710 is a BGAN terminal by default. However, if you are within coverage of a cellular network, you may want to acquire an EXPLORER Cellular Modem as an alternative to the BGAN network. Note that you need a separate SIM card for the cellular network, the EXPLORER 710 SIM card can only be used for the BGAN network.

Note The EXPLORER 710 does not provide automatic switch-over between BGAN and cellular network, so you have to select the network you want to use.

To enable the EXPLORER 710 to use the cellular network, do as follows:

1. Acquire an EXPLORER Cellular Modem from Cobham SATCOM.
2. Connect your computer to the EXPLORER 710 using the LAN or WLAN interface.
3. Access the web interface.

Note The USB interface must be enabled. See *USB interface setup on page 65*.

4. Under **Control panel > Terminal settings**, select one of the following at **Mode**:
 - **Cellular modem if available at power-up**
 - **Cellular modem only**, or
 - **User selection**.

For details on Cellular/BGAN network selection, see *Mode (select network) on page 74*.

5. When the modem is connected to the USB interface, the Dashboard of the web interface shows a new tile with the cellular connection. The “M” on the tile for the cellular modem indicates that it is a cellular modem and not a BGAN connection.

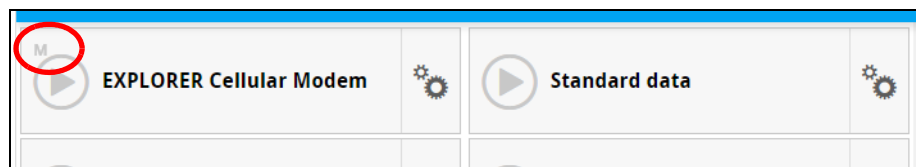

Note If you have selected **Cellular modem if available at power-up**, you have to restart the terminal before the cellular connection can be activated.

6. If you have selected **User selection** in step 4 above, you must first select the cellular network. Click the tile with the cellular modem, or click the signal strength icon  in the top right corner of the web interface. Then select EXPLORER Cellular Modem and click **OK**.

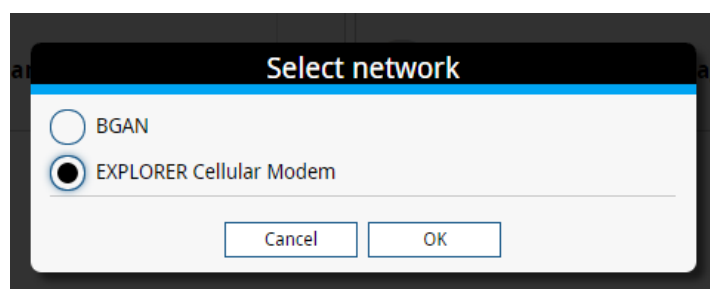

- If required, select  on the tile to set or change the name or the APN of your cellular connection. For details, see the next section.

When the connection is established, an “M” on the signal bar in the top right corner indicates that it is a cellular (Modem) connection, and the tile shows details about the connection.

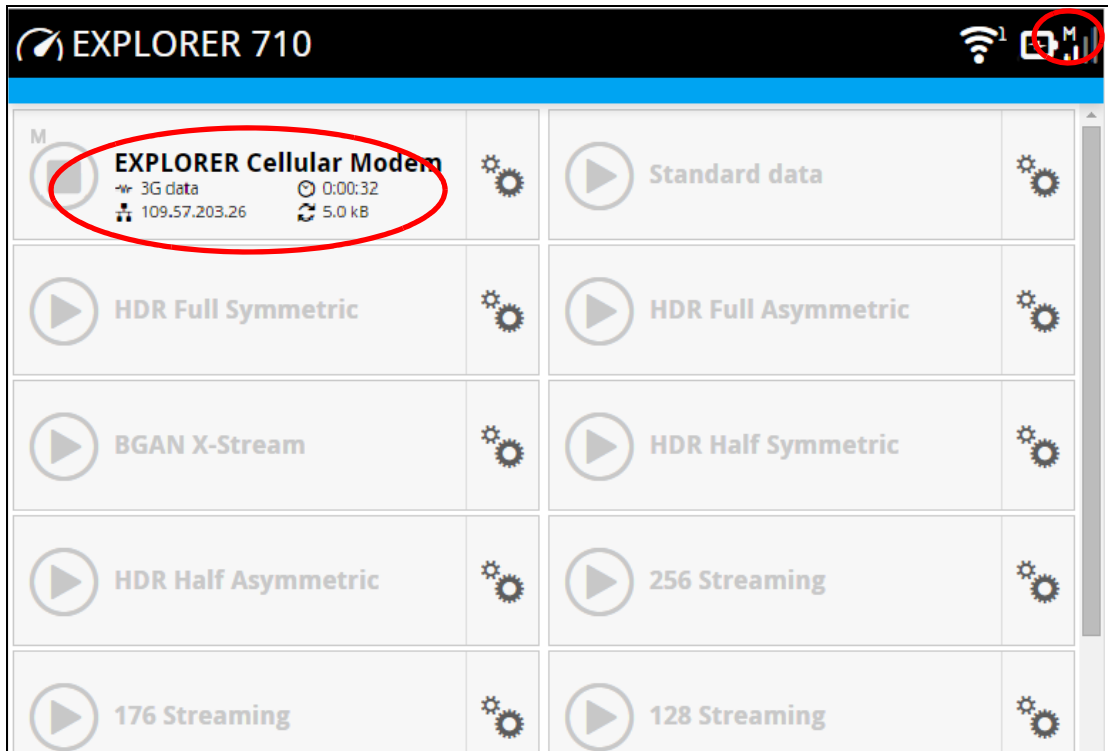

The data connection is automatically established when set up correctly, so you cannot start and stop the cellular connection from the tile as you can with the BGAN connections.

Note You may have to enter a PIN before you can use the cellular network, see *To enter the SIM PIN in the web interface on page 53*.

You can now access the Internet through the cellular network from a device connected to the EXPLORER 710. Note that you cannot use the BGAN network as long as EXPLORER Cellular Modem is selected.

Note You cannot make calls nor send SMS messages on the cellular network through the EXPLORER 710. Only data connection is possible over the cellular network. You can still send and receive SMS messages using the BGAN mobile number of the terminal (if the terminal is pointed and connected to the CS domain in the BGAN network).

To change the name or the APN for your cellular connection

Do as follows:

- Select  on the tile with the cellular connection.
- Type in the new name for your connection.
- Type in the name of the APN you are going to use for your cellular connection.
- Click **Save**.

Maintenance and troubleshooting

To get support

Contact information

Should your Cobham SATCOM product fail, contact your dealer or installer, or the nearest Cobham SATCOM partner. You will find the partner details on www.cobhamsatcom.com/where-to-buy. You can also access www.cobhamsatcom.com and select **COBHAM SYNC PARTNER PORTAL**, which may help you solve the problem. Your dealer, installer or Cobham SATCOM partner will assist you whether the need is user training, technical support, arranging on-site repair or sending the product for repair. Your dealer, installer or Cobham SATCOM partner will also take care of any warranty issue.

To repack for shipment

Should you need to send the product for repair, please read the below information before packing the product.

The shipping carton has been carefully designed to protect the EXPLORER 710 and its accessories during shipment. This carton and its associated packing material should be used when repacking for shipment. Attach a tag indicating the type of service required, return address, part number and full serial number. Mark the carton FRAGILE to ensure careful handling.

Note | Correct shipment is the customer's own responsibility.

If the original shipping carton is not available, the following general instructions should be used for repacking with commercially available material.

1. Wrap the defective unit in heavy paper or plastic. Attach a tag indicating the type of service required, return address, part number and full serial number.
2. Use a strong shipping container, e.g. a double walled carton.
3. Protect the front- and rear panel with cardboard and insert a layer of shock-absorbing material between all surfaces of the equipment and the sides of the container.
4. Seal the shipping container securely.
5. Mark the shipping container FRAGILE to ensure careful handling.

Failure to do so may invalidate the warranty.

Software update

Important

If the battery power is 25% or less you must connect DC power to the terminal before starting the software update. Once connected, do not remove DC power until the software update is completed.

To update software using the web interface

See *To update software* on page 71.

To update software from a remote location

Note

This method uses the satellite connection. Because the EXPLORER 710 is not an M2M terminal, this method may be expensive in airtime!

You can initiate a remote software upgrade with an AT command, either from the command interface or encapsulated in an SMS (ATCO command).

_IGETFW tells the terminal to get software from an FTP server and either upgrade the terminal software or download the software file to the terminal for later upgrade.

_IUPDFW tells the terminal to upgrade its software to the downloaded file.

For syntax and parameters, see *ATCO commands* on page 151.

Do as follows:

1. Download the new software¹ or acquire the software from Cobham SATCOM and place it on your FTP server.
2. To access the EXPLORER 710, use one of the following:
 - a computer connected to the Internet, see *To get remote access from a trusted IP address (preconfigured)* on page 40, or
 - equipment capable of sending and receiving SMS messages, see *Remote access with SMS* on page 37.

Note that you need a password for both access methods. For AT commands, use the **AT_ICLCK** command with the admin password, for SMS, use the remote SMS password.

3. Use the command **_IGETFW** to initiate the software download (and maybe upgrade) from the specified FTP server. If you are using the default APN this can be left out.

Example: `AT_IGETFW=1, "ftp.myftpserver.com", "ftp-username", "ftp-password"`

In this example, the terminal will get the software from the FTP server named **ftp.myftpserver.com** via the default APN and download and then upgrade the software in the terminal.

-
1. You can download the software from the “Cobham SYNC Partner Portal” at www.cobhamsatcom.com, select **Cobham SYNC Partner Portal > Downloads**. Locate the EXPLORER 710 software.

4. The terminal prepares for software update, connects to the specified FTP server and downloads the software image.
If you have selected **Deferred update** (_IGETFW=0), you have to use the command **_IUPDFW** followed by the software file name when you want the terminal to upgrade the software.
5. If you have selected **Immediate update** (_IGETFW=1), the terminal updates the system, reboots, installs the update and verifies the online connection.
6. When the software upgrade is successfully completed you get an AT or SMS command response with the message **Complete**.

Example: `_IUPDFW: 0, Complete`

To update software with USB

If the web interface is not available, you may also use the USB interface to update the software from a USB memory stick.

To prepare the USB stick

Do as follows:

1. Download the EXPLORER 710 software image from the Cobham SATCOM support server¹ to your computer.
2. Insert the USB memory stick into your computer and copy the EXPLORER 710 software image file to the drive.
3. Rename the file name to "tt3720b.tiif".
4. Remove the USB memory stick from the computer.

To upload the software to the EXPLORER 710

1. On the EXPLORER 710, check in the display that the USB interface is enabled.
2. Insert the USB memory stick with the new software into the EXPLORER 710 USB connector on the front.
The EXPLORER 710 reads the software image from the USB memory stick and starts the software update process. The EXPLORER 710 restarts and completes the software update. The Status LED flashes blue to indicate that the software update process is ongoing.
3. Wait for the status LED to become green to indicate the software update process is completed.
4. Remove the USB memory stick.

Recovery software update

If the EXPLORER 710 becomes inoperative, a recovery software update may bring it back into an operational state.

Important | The recovery software update will reset your EXPLORER 710 configuration to factory default!

To make a recovery software update, do as follows:

1. Prepare the USB stick as described in *To prepare the USB stick* on page 114.
2. In the display keypad, hold down the "<" and ">" keys while powering on the EXPLORER 710. The EXPLORER 710 powers up and the display shows: SAFE MODE.
3. Insert the USB memory stick with the new software into the EXPLORER 710 USB connector on the front.
The EXPLORER 710 reads the software image from the USB memory stick and starts the software update process. The EXPLORER 710 reboots and when it is powered up the Status LED flashes blue to indicate that the software update process is ongoing.
4. Wait for the status LED to become steady green to indicate the software update process is completed.
5. Remove the USB memory stick.

Maintenance

Normal use of the battery

It is recommended not to partially charge/discharge the battery several times in a row. Partial charging/discharging affects the accuracy of the capacity measurement.

To recharge batteries

One battery inserted

To recharge the battery, connect external power to the DC input of the EXPLORER 710 while the battery is inserted. For details on how to apply external power, see *DC input* on page 15.

Two batteries connected

Note | When two batteries are connected (internal and external), only one at a time is active.

You may connect an extra, external EXPLORER 710 battery for extra capacity. When external power is applied to the EXPLORER 710, both batteries are charged as follows:

One battery is charged to 80%. Then the other battery is charged to 80%, and finally they are both charged the last bit up to 100%, one at a time. This way both batteries are charged in the shortest possible time.

The display and the web interface of the EXPLORER 710 show battery status such as which battery is currently charging and the battery level.

Deeply discharged batteries (precharge mode)

Never leave the battery fully discharged for a longer period of time. If the battery is not to be used for a shorter period of time (1 month), charge the battery to minimum 20 to 30% and remove it from the EXPLORER 710. If the Battery is stored for more than a month, see *Storage* at the end of this section.

If a battery has not been used for a long time and has been discharged below its normal operation range the EXPLORER 710 will not be able to apply the normal battery charging mode. In this case an Alert is generated ("Internal/External battery low voltage") and the EXPLORER 710 will use a precharging mode to recover the battery. The battery status in the local display and the web interface will show "Precharging". No time estimate or battery capacity will be indicated. Depending on how deeply discharged the battery is, the precharging might process for up to 6 hours. After precharging, the EXPLORER 710 will proceed with the normal battery charging.

To connect an extra, external EXPLORER 710 battery

If you are not close to a power source, you may want to use an extra EXPLORER 710 battery as backup. Do as follows:

1. Acquire an extra EXPLORER 710 battery with a dedicated EXPLORER 710 Hot Swap Cable (part number 403720B-010).
2. Connect the dedicated cable between the external EXPLORER 710 battery and the **Ext. Battery** connector on the EXPLORER 710.

The EXPLORER 710 continues normal operation on the inserted battery until it runs out of power.

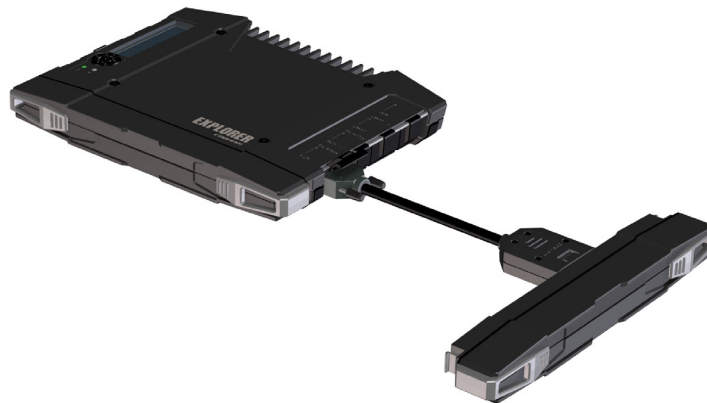

3. When the inserted battery runs out of power, the EXPLORER 710 switches to the external battery and continues normal operation.

Important

Before removing the empty battery, click/select the battery symbol in the web interface or the display and make sure that the EXPLORER 710 is actually running on the external battery.

4. If you have a third charged battery ready, you can now take out the inserted battery and replace it with the new one, without interrupting the operation of the EXPLORER 710.

Accurate display of the battery capacity

To ensure accurate display of the battery capacity, it is recommended to run a “learning cycle” at first time use and then at regular intervals (approximately for every 100 recharge/discharge cycles). The learning cycle must be performed at 20°C-30°C.

A learning cycle is performed as follows:

1. Fully charge the battery.
2. Remove external power and fully discharge the battery:
Use the EXPLORER 710 and/or leave it on until it turns off automatically. This way the EXPLORER 710 “learns” the complete capacity of the battery. Note that it may take several hours to discharge the battery if it is not in use.
3. Fully recharge the battery.

Storage

Do not leave the battery inserted in the EXPLORER 710 during storage. If the battery is not to be used for a longer period of time, do as follows:

1. Remove external power. Then use the EXPLORER 710 or leave it on until the display shows a battery capacity of approximately 50-70%.
2. Switch off the EXPLORER 710.

Important

Switch off the EXPLORER 710 before removing the battery!

3. Remove the battery and store it.

For information on storage temperature and duration, see *Battery specifications* on page 135.

Disposal of the EXPLORER 710

Old electrical and electronic equipment marked with this symbol can contain substances hazardous to human beings and the environment. Never dispose these items together with unsorted municipal waste (household waste).



In order to protect the environment and ensure the correct recycling of old equipment as well as the re-utilization of individual components, use either public collection or private collection by the local supplier of old electrical and electronic equipment marked with this symbol.

Contact the local supplier for information about what type of return system to use.

Troubleshooting

Troubleshooting guide

Problem	Possible cause	Remedy
The EXPLORER 710 cannot be switched on, or does not stay on when powered by the battery.	The battery needs recharging.	Recharge the battery. Check the battery indicator in the display.
	The battery is not inserted properly.	Remove the battery and re-insert it. Make sure the battery is inserted properly and that the latches are locked.
	The battery contacts are dirty or damaged.	Clean the battery contacts if necessary. If the contacts are damaged, replace the battery.
The EXPLORER 710 cannot be switched off.	The Power button was not held long enough.	When you switch off the EXPLORER 710, hold the power button until the light indicator flashes rapidly yellow. In rare cases, it may take up to 10 seconds to switch off the EXPLORER 710.
Charging error	The temperature is outside the limits for charging.	Only charge the battery when the temperature is within the specified range. See <i>Charge temperature</i> on page 135.
	The charging voltage is lower than the specified minimum voltage.	Wait until charging begins (the Status indicator flashes yellow). If the battery is completely discharged, and it has been out of use for a long time, the charging process may take a long time to start. If charging does not begin within 2-3 hours, contact your local supplier, or purchase a new battery.
The EXPLORER 710 is not operational.	Software error	Restart the terminal. If the problem persists, you can make a recovery software upload as described in <i>Recovery software update</i> on page 115. Note: This will reset the configuration of your terminal to factory default!

Problem	Possible cause	Remedy
The display shows Insert SIM.	The SIM card is not present.	Remove the battery and insert the SIM card in the SIM slot according to the instructions in the section <i>To insert the SIM card</i> on page 12.
	The SIM card is not inserted properly.	Remove the SIM card and re-insert it according to the instructions in the section <i>To insert the SIM card</i> on page 12.
The display shows No position fix.	The EXPLORER 710 is unable to register on the network, because the position is unknown.	Make sure the view to the GNSS satellites is not blocked. To obtain position fix, the EXPLORER 710 should be placed flat on an even surface pointing straight upwards, with a clear view to as much of the sky as possible. When the EXPLORER 710 has obtained position fix, you can point the antenna towards the BGAN satellite. To see the position status, select  in the display.
The display shows Emergency calls only.	The BGAN network is only available for emergency calls. The reason may be one of the following: 1) Your Airtime subscription has expired. 2) You are using the wrong SIM card. 3) No SIM card is inserted. 4) You have canceled the PIN	1) Check your subscription with the Airtime Provider. 2) Check that your SIM card is valid for communication on the BGAN network. 3) Insert the SIM card 4) Enter the PIN
The display shows Not registered.	The EXPLORER 710 cannot register on the BGAN network.	Check that your SIM card is valid for communication on the BGAN network. Check your subscription with the Airtime Provider.

Problem	Possible cause	Remedy
The display shows External control.	The EXPLORER 710 is currently controlled by an external application, e.g. LaunchPad or an AT command interface.	If you want to use the built-in web interface or the display, stop the external application and restart the EXPLORER 710. Then open your browser and access the web interface.
The display shows SIM locked	The SIM card is locked by the supplier e.g. to a specific provider	Contact your supplier
The EXPLORER 710 cannot obtain its position from the GNSS system.	There is no GNSS signal, or the signal is weak. If the EXPLORER 710 has not been used recently within the same location, it can take up to 10 minutes to obtain the position.	Check the GNSS status in the display or the web interface. To help the EXPLORER 710 obtain position fix, it should be placed flat on an even surface pointing straight upwards, with a clear view to as much of the sky as possible. When the EXPLORER 710 has obtained position fix, you can point the antenna towards the BGAN satellite.
No signal or weak signal from the BGAN satellite.	The view to the satellite is blocked.	Make sure the EXPLORER 710 has a clear view to the satellite. Be aware that window glass may reduce the signal level.
	The antenna is pointed in the wrong direction.	Check that the antenna is pointed according to the position data. Adjust the position to the highest possible signal strength.
Connection to the Internet cannot be established.	The signal strength is too low.	Check that the antenna is pointed according to the position data. Adjust the position to the highest signal strength you can obtain. As a rule of thumb, you should have a signal strength of 45 dBHz or more to be able to make a call or data session.

Problem	Possible cause	Remedy
The web interface cannot be accessed.	The browser is configured to use a proxy server.	For Microsoft Internet Explorer, select Tools > Internet Options > Connections > LAN Settings and uncheck Use a proxy server for your LAN .
	You have entered a wrong IP address.	Check the IP address and re-enter it. The default IP address is 192.168.0.1
A Phone connection cannot be established.	The interface is disabled in the EXPLORER 710.	Enable the interface by selecting the Phone interface icon in the display, or by accessing the web interface and selecting Control panel > Phone > Enable .
	The cable is not properly connected.	Connect the cable.
	The cable type or connector type is not correct.	For information on the correct type of connector, refer to <i>Phone interface</i> on page 137.
	Incoming calls: The call type used for the call is not selected in the web interface.	Make sure the call type used for calls to the EXPLORER 710 is selected in the web interface. Access the web interface and select Control panel > Phone . Then select the call type for incoming calls.

Problem	Possible cause	Remedy
An ISDN connection cannot be established.	The ISDN interface is disabled in the EXPLORER 710	Enable the interface by selecting the ISDN interface icon in the display, or by accessing the web interface and selecting Control panel > ISDN > Enable .
	The cable is not properly connected.	Connect the cable.
	You have connected to the LAN interface.	Connect the cable to the interface marked ISDN.
	The cable type or connector type is not correct.	For information on the correct type of connector and cable, refer to <i>ISDN interface</i> on page 138.
	Incoming phone calls: The call type used for the call is not selected in the web interface.	Make sure the call type used for calls to the EXPLORER 710 is selected in the web interface. Access the web interface and select Control panel > ISDN . Then select the call type for incoming calls.
A LAN connection cannot be established.	The interface is off in the EXPLORER 710.	Enable the interface by selecting the LAN interface icon in the display, or by accessing the web interface and selecting Control panel > LAN > Enable .
	The cable is not properly connected.	Connect the cable.
	The cable type or connector type is not correct.	For information on the correct type of connector and cable, refer to <i>LAN interface</i> on page 139.
	You have connected to the ISDN interface.	Connect the cable to the interface marked LAN#1 or LAN#2.

Problem	Possible cause	Remedy
A WLAN connection cannot be established.	The WLAN interface is disabled in the EXPLORER 710	Enable the interface by selecting the WLAN interface icon in the display, or by accessing the web interface and selecting Control panel > WLAN > Enable .
	Your computer or smartphone is placed too far away from the EXPLORER 710.	Bring the computer closer to the EXPLORER 710. Note that the specified maximum distance is only valid under ideal conditions.
The USB (Host) interface does not work.	The interface is off in the EXPLORER 710.	Enable the interface by selecting the USB interface icon in the display, or by accessing the web interface and selecting Control panel > USB > Enable .
The BGAN menu is not showing in the Thrane IP Handset	Thrane IP Handset is not enabled from the web interface page Security .	Enable the use of Thrane IP Handset in the web interface under Control Panel > Advanced > Security .
Entered AT commands return with an error.	The EXPLORER 710 is set up to require a password to access the terminal using AT commands.	Enter the administrator password using the command <code>_ICLCK</code> . If you do not want the terminal to require a password for AT commands, change this setting under Control Panel > Advanced > Security .

Status signaling

Means of signaling

The EXPLORER 710 system provides two methods for signaling the status of the system.

- **Status indicator** next to the display keypad
- **Messages** shown in the display and in the web interface.

Status indicator

The EXPLORER 710 has one light indicator showing status.



Note Errors (red constant) and Warnings (yellow constant) override other indications.

Indicator pattern		Meaning
●	Green flashing rapidly	Starting up
●	Green flashing slowly	Power on (ready)
●	Green constant	Power on with DC input
●	Yellow flashing slowly	Battery charging
●	Yellow flashing rapidly	Closing down
●	Yellow constant	Warning (user recoverable)
●	Red constant	Error. See the display or the web interface.
●	Blue flashing	Uploading software to the terminal
○	Off	Power off

Event messages and status messages

In the display of the EXPLORER 710 you can see status messages and alerts that are currently active.

When an alert is active, the display shows a warning symbol . Select it to see a list of currently active alerts.

List of messages

The following list explains some of the messages that may show in the display and in the web interface of the EXPLORER 710.

Event ID (Hex)	Displayed text	Explanation	Remedy
1010	Temperature too low (critical)	Low ambient temperature is causing the performance of the terminal to be degraded or halted.	Move the terminal to a warmer location. For information on ambient temperature limits, see the Specifications appendix.
1020	Too low temperature warning	Low ambient temperature is causing the performance of the terminal to be degraded or halted.	Move the terminal to a warmer location. For information on ambient temperature limits, see the Specifications appendix.
1110	Temperature too high (critical)	Terminal: Critically high temperature is causing the terminal to shut down. Antenna: Critically high temperature is causing the antenna to stop transmission.	If possible, move the failing unit to a cooler location. For information on ambient temperature, see the Specifications appendix. Contact your distributor if the problem persists.
1120	Too high temperature warning	High ambient temperature is causing the performance of the system to be degraded or halted. The bit rate is reduced.	Move the terminal to a cooler location. For information on ambient temperature limits, see the Specifications appendix.
1200	Battery level low	The battery level is low.	Charge the battery. See <i>To recharge batteries</i> on page 116.
1400	Satellite signal lost	The system no longer receives a signal from the satellite.	Make sure the antenna has a clear view to the satellite.
1600	SIM blocked	The SIM card is not accepted by the network, e.g. because you have entered too many wrong PINs and PUKs. Only emergency calls are allowed.	Enter the PIN and wait for network approval. If the problem persists, contact your airtime Provider.
1700	Registration for voice failed	The system has not yet been allowed to register for voice services (Circuit Switched).	If the problem persists, contact your airtime provider.

Event ID (Hex)	Displayed text	Explanation	Remedy
1800	Registration for data failed	The system has not yet been allowed to register for data services (Packet Switched).	If the problem persists, contact your airtime provider.
2900	Network failed authentication	The system does not accept the network as a valid BGAN network.	Restart the system. If the problem persists, contact your distributor.
3900	Air link error	Error condition in DSP which modulates and demodulates BGAN signal.	Reboot the terminal. Contact your distributor if the problem persists.
8030	Antenna could not enter main application mode	Antenna failed to start up normally.	Reboot the terminal. Contact your distributor if the problem persists.
8035	Antenna connection lost. Power off terminal and check antenna cable.	There was an error communicating with the antenna.	Reboot the terminal. Contact your distributor if the problem persists.
8049	Data rate reduction due to high temperature	The bit rate of the data channel is reduced because the temperature is too high.	Move the terminal to a cooler location.
8056	SIM rejected	The type of USIM card inserted in the terminal is not correct for your terminal.	Make sure you have the correct type of USIM card. For example, an USIM card for a land mobile system will not work for a maritime system and vice versa.
8098	Measured DC resistance in antenna cable is too high	The DC resistance in the antenna cable is too high. May be caused by corrosion or poor connections.	Ensure antenna cable connector has no corrosion. Ensure all antenna cable connectors are tightly screwed together.
921E	Antenna input voltage outside range	Voltage to HPA in antenna out of range.	Check voltage to terminal is in range 10 - 32 V DC. Check that antenna cable connections are sufficiently tightened.
9220	Antenna temperature above critical limit	Antenna temperature too high, might affect performance.	If possible, move the antenna to a cooler location.

Event ID (Hex)	Displayed text	Explanation	Remedy
9221	Antenna gain outside range	Gain setting calculated in HPA in antenna is out of range	Reboot the terminal. If the problem persists, contact your distributor.
9223	Antenna input voltage not what terminal expected	Antenna voltage not as expected.	Reboot the terminal. If the problem persists, contact your distributor.
10117	PIN for cellular modem required	The SIM card for your cellular connection requires a PIN code	You can enter the SIM PIN for the cellular modem from the web interface.
10118	PUK for cellular modem required	The SIM card for your cellular connection requires a PUK code, because too many wrong PINs were entered.	Enter the PUK for the cellular SIM card in the web interface.
1011B	Cellular modem SIM card error	There is an error with the SIM card in the cellular modem	Check that you have inserted the correct SIM card, and that it is inserted properly.
1011C	Cellular modem error	There is an error with the cellular modem. The text in the web interface will normally show more details on the type of error, e.g. unknown APN.	Check that the APN for the cellular connection is set up correctly. You can set up the APN in the web interface: In the Dashboard click in the right side of the tile with the Cellular Modem.
1011D	Cellular modem not supported	The connected cellular modem is not supported by the terminal.	Connect a cellular modem that is supported.
10203	USB power limited to 0.5A due to high temperature	The current is limited to 0.5 A in the USB interface, even if it is set to 1.0 A in the web interface, because the temperature is too high.	If 0.5 A is not enough for the device connected to the USB interface, move the terminal to a cooler location.
10204	Standard data speed limited due to high temperature	The bit rate of the data channel is reduced because the temperature is too high. All Streaming contexts are closed.	Move the terminal to a cooler location.
10205	Closing all connections due to high temperature	All data connections, background and streaming are closed.	Move the terminal to a cooler location.

Event ID (Hex)	Displayed text	Explanation	Remedy
10206	Closing terminal due to high temperature	Terminal has reached a critically high temperature, and will reboot by itself.	Move the terminal to a cooler location.
10208	POE disabled due to high temperature	The temperature in the terminal is too high. PoE is disabled to reduce the temperature. (not port 1)	Move the terminal to a cooler location, or avoid using PoE.
10300	Updating software...	Software update has begun.	Wait for the software update to complete.
10301	Do not remove DC power from terminal during software update	Software update is ongoing and the battery is low. Do not remove DC power from the terminal while software update is ongoing.	If DC power is not connected, connect it as soon as possible and leave it connected until software update is completed.
10302	Preparing for software update	Initial preparations for software upload are started.	Wait until preparations are over, either the terminal is rebooted or an error is shown.
10303	Error opening software file	The file requested to use for the update procedure cannot be opened or found.	Make sure the update file is correct and the file exists. Use the command _IUPDFW? to show the correct file name before updating.
10304	Battery level too low for software update	The battery level is too low to perform software update.	Charge the battery (connect to DC power) before updating the software.
10305	Software downgrade prevented. Use a newer software version.	Not possible to perform a software downgrade, use a newer version.	Use a newer version of software for the update, or contact your distributor.
10306	File does not support this product	The file used for software update does not support this product.	Use the correct tiif file
10307	File is corrupt. Download the file again.	The file used for software update appears to be corrupt and the content cannot be validated.	Download the file again

Event ID (Hex)	Displayed text	Explanation	Remedy
10308	Software update failed. Try running the update again.	Software upload failed to initialize, can be a sporadic issue.	Try running the update again. If the problem persists, contact your distributor.
10309	Software update failed. Update to the latest software version.	The software has been rolled back to the previous version prior to starting the software upload. The new image was not validated correctly.	Try running the update again, if the problem persists, contact your distributor.
1030A	Software failed. Update to the latest software version from Safe Mode.	Not all subunits have been properly verified with the new image.	Attempt software update procedure again, alternatively from Safe Mode if the problem persists.
1030B	Antenna software failed. Update to the latest software version from Safe Mode.	The antenna software could not be verified.	Attempt software update procedure again, alternatively from Safe Mode if the problem persists. The antenna is a subunit with relation to the software update process, and if that particular unit fails, this event is raised instead of 0x1030A
1030C	Software update is already started	Another software update cycle is currently running.	Wait until the current software upload has finished.
1030D	Software version is already installed	The software image you are trying to install is already active on the terminal.	Update with a different image as it is prohibited (and nonsensical) to start a sw update process with the same image.
1030E	Software update forced roll-back	Software update failed and the terminal forced a roll-back to the previous version.	Check that you have the correct file for software update and try again. If the problem persists, contact your distributor.
11001	Calibration error	Invalid calibration values found.	Contact your distributor.

Event ID (Hex)	Displayed text	Explanation	Remedy
11002	Battery level low	The battery level is low	Charge the battery. See <i>To recharge batteries</i> on page 116.
11003	Temperature too low for charging	The temperature is lower than the minimum charge temperature.	Only charge the battery when the temperature is within the specified range. See <i>Charge temperature</i> on page 135.
11004	Temperature too high for charging	The temperature is higher than the maximum charge temperature.	Only charge the battery when the temperature is within the specified range. See <i>Charge temperature</i> on page 135.
38404	WLAN control	WLAN failed to start up normally.	Restart the terminal. Contact your distributor if the problem persists.

Log files

Diagnostics report

When contacting Cobham SATCOM for support, please include a diagnostic report.

The diagnostic report contains information relevant for the service personnel during troubleshooting.

To generate the diagnostic report, access the web interface and select **Control panel > Support > Diagnostics report**. Then click **Generate report**.

Call log and data log

The log holds detailed information on each call or data session to and from the EXPLORER 710, including date and time, phone numbers, duration, amount of data transferred etc.

Date and time is UTC time, received from the satellite.

For information on how to view the log in the web interface, see *To use the logs* on page 61.

Event log

The Event log shows events that occurred in the past and are no longer active. It includes events of informational character describing normal phases of operation for the terminal, and also alerts that have appeared in the Alerts list.

To view the event log in the web interface, select **Event log** from the **Support** page.

List of reserved IP subnets

Some IP subnets are reserved for internal use in the terminal. If any of these addresses are assigned to external equipment connected to the terminal, the terminal and connected equipment will not be able to communicate.

1. The following local IP subnets are **reserved for internal use** in the terminal and cannot be assigned to connected equipment:
192.168.1.x and **192.168.2.x** -where x can be any number from 0 to 255.
The netmask for these subnets is 255.255.255.0.
2. **Do not use 0 nor 255** at the least significant bit position (rightmost) in the IP address for connected equipment.
3. Furthermore the following local IP addresses are **reserved** and cannot be assigned to connected equipment:
192.168.50.1
192.168.51.1
192.168.52.1
192.168.53.1
192.168.54.1
192.168.55.1
192.168.56.1
192.168.57.1
192.168.58.1
192.168.59.1
192.168.60.1

192.168.61.1
192.168.61.2
192.168.61.3
192.168.61.4
192.168.61.5
192.168.61.6
192.168.61.7
192.168.61.8
192.168.61.9
192.168.61.10
192.168.61.11

Technical specifications

General specifications

Item	Specification
Type	EXPLORER 710, BGAN Class 1 terminal
Max. IP data rate, Rx/Tx ^a Streaming data	492 kbps/492 kbps (simultaneously) 16, 32, 64, 128, 176 and 256 kbps, BGAN X-Stream, HDR Full asymmetric and symmetric, HDR Half asymmetric and symmetric
Physical dimensions	332 x 279 x 54 mm 13.07 x 10.98 x 2.13 inches
Weight	3.5 kg / 7.7 lbs (incl. battery)
Operating temperature Powered by external DC (no battery or fully charged battery) DC operated and charging the battery Powered from battery (discharging) Storage temperature Without battery With battery	-25 to 55°C 0 to 45°C -20 to 55°C -40 to 85°C 9 months at -20 to 25°C 3 months at -20 to 45°C 1 month at -20 to 60°C
Water & Dust Transceiver Antenna	IP52 IP66
Supported web browsers (Others may be supported, these have been tested.)	Safari 5.1.7 and above Internet Explorer 9.0 and above Google Chrome 23 and above Mozilla Firefox 16 and above

a. Performance depends on a wide range of factors and actual usage.

Battery specifications

Item	Specification
Battery type	Lithium Ion
Voltage	10.95 Volt
Capacity	Typ. 5700 mAh
Time between recharging	
Tx time, max	2h30m @ 144 kbps 1h30m @ 492 kbps
Rx time, max	3h30m @ 492 kbps
Charge time	2h. 30 min. charge time
Charge temperature	0 to 45°C (in Japan: 10 to 45°C)
Min. charge cycles	300 (typically up to 500)
Storage temperature	
1 month	-20 to 60°C
3 months	-20 to 45°C
9 months	-20 to 25°C

Interfaces specifications

Power input

Connector pin-out

This drawing shows the pin-out for the DC Power connector.

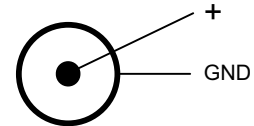

Specifications

Item	Specification
DC input range	+10 to +32 VDC
Power consumption	up to 65 W depending on usage
Connector type	Power Jack - 2,5 mm Center

AC/DC adapter

Item	Specification
AC input range	100 to 240 VAC, 1.5 A, 47 to 63 Hz
DC output	19 VDC, 65 W

External battery connector

The external battery connector is a custom connector strictly for connecting a Cobham SAT-COM EXPLORER 710 battery with a dedicated EXPLORER 710 Hot Swap Cable (part number 403720B-010).

Phone interface

Connector pin-out

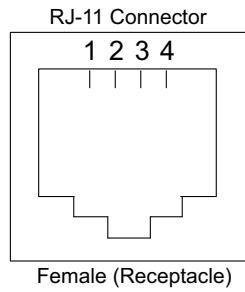

Pin	Function
1	NC
2	Tip
3	Ring
4	NC

Specifications

Item	Specification
Connector type	RJ-11, female
Impedance	User selectable in web interface, EURO is default. <ul style="list-style-type: none"> • EURO: 270 Ohm + 750 Ohm / 150 nF, or • USA/ Canada/ Japan: 600 Ohm
Max. cable length	100 m / 80 Ohm

ISDN interface

Connector pin-out

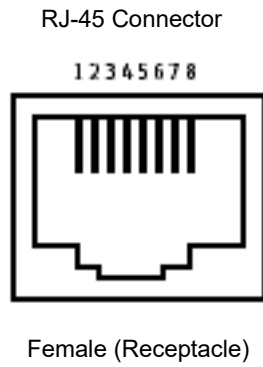

Pin	Function
1	NC
2	NC
3	Rx+
4	Tx+
5	Tx-
6	Rx-
7	NC
8	NC

Specifications

Item	Specification
Connector type	RJ-45, female
Data rate	
Voice	4 kbps
Data	64 kbps
Audio	3.1 kHz
Max. cable length	100 m

LAN interface

Connector pin-out

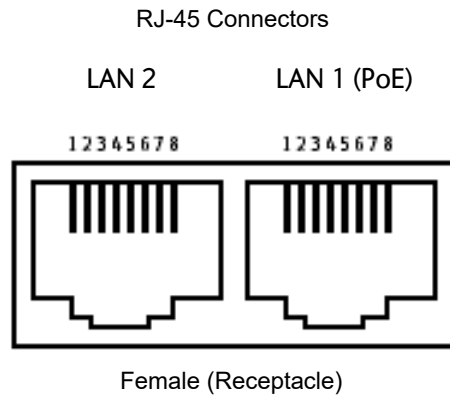

Pin	LAN 1 (PoE)	LAN 2
1	Rx+ (PoE+)	Rx+
2	Rx- (PoE+)	Rx-
3	Tx+ (PoE-)	Tx+
4	NC	NC
5	NC	NC
6	Tx- (PoE-)	Tx-
7	NC	NC
8	NC	NC

Specifications

Item	Specification
Number of connectors	Dual
Connector type	RJ-45, female, Auto cross-over MDI/MDI-X (IEEE 802.3 10/100BaseT)
Standard	ISO/IEC 8877:1992 and IEEE 802.3 1998 Edition
Max. data rate	10/100 Mbps
Max. cable length	100 m / 328 ft with Cat5 UTP
PoE (only on LAN 1)	IEEE 802.3af 2003 Edition, Class 3

WLAN access point

Specifications

Item	Specification
Standard	IEEE 802.11 b/g
Antenna	External rotatable antenna for increased coverage
Frequencies	2.4 GHz ISM band
Max. coverage outdoor	100 m / 328 ft

USB (Host) interface

Connector pin-out

Pin	Function
1	VBUS
2	D-
3	D+
4	GND

Specifications

Item	Specification
Version	USB v2.0 Host
Connector type	Type A
Charge current available	0.5 A or 2.0 A, user selectable
Max. cable length	5 m / 16.4 ft

Antenna interface on transceiver

Specifications

Item	Specification
Connector type	TNC, female
Max. cable length	Typically up to 100 m depending on the cable type
Max. cable loss	Max 20 dB cable loss at 1.5 to 1.7 GHz Max 3 dB cable loss at 50 to 60 MHz
Max. DC impedance for cables	Max. 1.8 Ohm DC resistance.

Detachable BGAN antenna specifications

Item	Specification
Type	Directional patch array, manually adjustable
Polarization	RHCP, Right-hand circular polarization for both tx and rx
Connector type	TNC
Frequencies	
Inmarsat I-4	
Transmit	1626,5 MHz - 1660,5 MHz
Receive	1525 MHz - 1559 MHz
Inmarsat Alphasat	
Transmit	Extended L-band (XL) ^a : 1626,5 MHz - 1660,5 MHz and 1668 MHz - 1675 MHz
Receive	1518 MHz - 1559 MHz
GNSS	GPS or GLONASS
EIRP	Nominal: 20.0 dBW (EIRP), Class 1

a. Only available within Alphasat coverage. See *Satellite coverage* on page 142.

Satellite coverage

The EXPLORER 710 uses the Inmarsat I-4 satellites and the Alphasat satellite for satellite communication. The drawing below shows the coverage areas for these satellites.

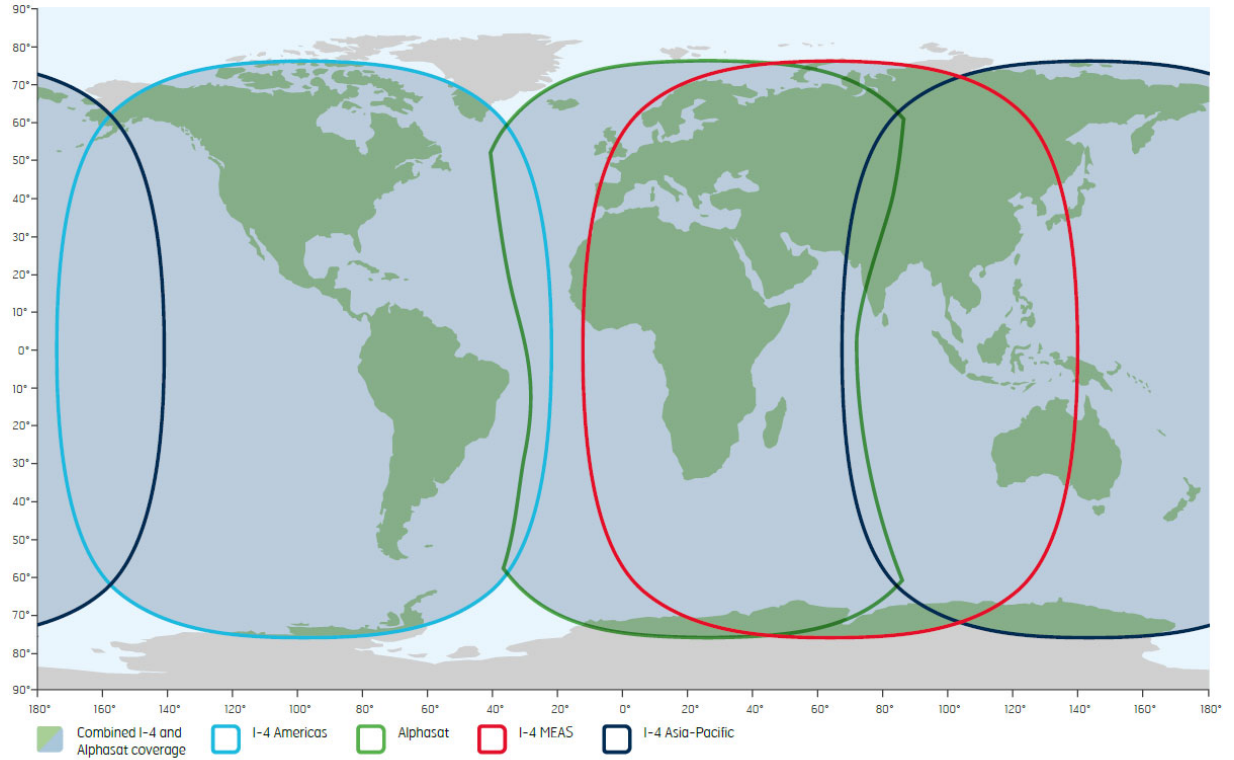

Command reference

This appendix lists the function, syntax and parameters for commands used with the EXPLORER 710. You can send commands to the EXPLORER 710 either with an SMS or via AT shell. SMS is very useful for remote operation, because you only need the terminal's mobile number to access the terminal. This appendix has the following sections:

- *Overview of M2M AT and SMS commands*
- *SMS remote commands*
- *AT commands*

Overview of M2M AT and SMS commands

Function	Command	Interface		
		AT shell	ATCO SMS	SMS
Lock and unlock AT shell	_ICLCK	X		
Control MAC address locking	_IMACLOC	X		
Configuration of MAC address list	_IMACLOCAD	X		
Control remote SMS commands	_ISMSRMT	X		
Reset passwords	_ICPWD	X	X	
Control remote access to web interface	_IREMWEB	X	X	
Download and update SW	_IGETFW	X	X	
Install new SW	_IUPDFW	X	X	
Send file from terminal to FTP server	_ISENDFILE	X	X	
Get file from FTP server to terminal	_IGETFILE	X	X	
Update configuration file	_IUPDCFG	X	X	
Get input voltage of the EXPLORER 710	_ITDCIV	X	X	
Administrator password control	ADPWRST			X
Activate PDP context	ACTIVATE			X
Deactivate PDP context	DEACTIVATE			X
Delete SMS messages	CLEAR			X
Get terminal information	GETINFO			X
Restart the terminal	RESTART			X
Configuration of Connection watchdog function	WATCHDOG			X
Configuration of Terminal watchdog function	ADVWATCHDOG			X
Configuration of WAN mode	WANMODE			X

SMS remote commands

This section describes syntax and parameters for the SMS commands. For examples of use, see *Remote access with SMS on page 37*

Syntax conventions

Syntax definitions use the following conventions:

- <parm> indicates that a parameter (without < and >) can be filled in by the user.
- { <opt1> | <opt2> | ... | NA } indicates that one of various options must be chosen by the user. Use **NA** when no value is defined.
- Keywords and parameters are separated by the space (ASCII 32) character.
- The command name and all keywords must be in upper case; most user-provided parameters are case sensitive but may be either case.
- **TE** means Terminal Equipment - the equipment connected locally to the EXPLORER 710.

SMS remote command summary

Commands

The table below summarizes the available SMS remote commands. The password comes just after the last parameter (except for the ATCO command, see below). For examples, see *Remote access with SMS on page 29*.

Command	Parameters	Password
ACTIVATE	<qos> <PC/TE type> <apn> <user> <pwd>	<rsms_pwd>
ADPWRST	1 <imei>	<rsms_pwd>
ADVWATCHDOG	<get/set> <wdog_enable> <wakeup> <interval> <ping1> <ping2> <ping3> <apn_type> <apn> <user> <pwd> <pos_response> <sms_number>	<rsms_pwd>
CLEAR	<category> SMS	<rsms_pwd>
DEACTIVATE	<qos> <PC/TE type>	<rsms_pwd>
GETINFO	<info_mode> <dataset>	<rsms_pwd>
RESTART	<reset_type> BGAN	<rsms_pwd>
WATCHDOG	<wdog_op> <ping1> <ping2> <ping3> <ping_always> <ping_interval> <wdog_enable>	<rsms_pwd>
WANMODE	<cmd_op> {<wanmode>}	<rsms_pwd>
SMS command for sending AT commands		
ATCO	<resp_mode> <rsms_pwd> <at_cmd>	

Parameters

The table below summarizes the available parameters for the SMS remote commands.

Parameter	Values	Meaning
<apn_type>	SIM default Network assigned User defined NA	Read the APN from the SIM card. Use the APN assigned by the network. Specify another APN to use. Placeholder when no value is specified. The existing setting applies.
<apn>	<APN> NA CLR	APN name, e.g. bgan.inmarsat.com . Placeholder when no APN is specified. Note that any previously entered APN is maintained. No APN is used.
<at_cmd>	<at_cmd>	AT command, without prefix AT. For supported AT commands, see <i>ATCO commands on page 151</i> .
<category>	1 2 3 4	Delete only Read SMS messages. Delete Read and Sent. Delete All except Unread. Delete All SMS messages.
<cmd_op>	1 2	Get WANMODE setting Set WANMODE configuration
<dataset>	GPS USAGE ALL	GPS position. Cumulative call time and data usage. GPS position plus call time and data usage.
<get_set>	1 2	Get parameters. Set parameters.
<imei>	<14 digits>	IMEI of the EXPLORER 710, without dashes or check digit.
<info_mode>	1 2	For GPS query: position data only. For other queries: use verbose mode (with titles). For GPS query: position data plus SMS usage. For other queries: use terse mode (no titles).
<interval>	<integer> NA	The number of hours between the Terminal watchdog sessions (1-504). Placeholder when no value is specified. The existing setting applies.
<PC/TE type>	DHCP STATIC AWO <name> <IP addr> ANY	All TEs known via DHCP. All TEs known via Terminal settings. Always On, deactivate all PDP contexts including those established with ACA. Name of specific TE, as known by DHCP server. IP Address of specific TE (or Global IP for DEACTIVATE). Any/all TEs attached (DEACTIVATE: all except PDP context established with ACA).

Parameter	Values	Meaning
<ping_always>	0 1 NA	Send ping only if no traffic. Always send ping, regardless of data traffic. Placeholder when no value is specified. Note that the existing setting applies.
<ping_interval>	<integer> NA	Interval between pings (minutes). Placeholder when no value is specified. Note that the existing setting applies.
<ping[1/2/3]>	<IP addr> NA	Three ping destination IP addresses. Note: You must fill in all three places. 0.0.0.0 means any previously entered IP address in this position is deleted. Placeholder when no IP address is specified. Note that any previously entered IP address is maintained.
<pos_response>	0 1 NA	Send an sms response ^a . Do not send an sms response ^a . Placeholder when no value is specified.
<pwd>	<APN password> NA CLR	Password associated with APN username. Placeholder when no APN password is specified. Note that any previously entered password is maintained. Password is not used.
<qos>	1	Standard/background data (currently the only qos available for M2M).
<reset_type>	1	Normal delay restart.
<resp_mode>	0 1 2 3	None – send no responses to AT commands. Immediate - immediate responses, but not unsolicited. Final – suppress immediate if OK, plus unsolicited. All – send both immediate and unsolicited responses.
<rsms_pwd>	<rsms_pwd>	Remote SMS password. The password must be 5 to 15 characters long and cannot contain spaces. Accepted characters are: A through Z (uppercase characters), a through z (lowercase characters) and 0 through 9 (numeric characters).
<sms_number>	<sms_number> NA	The phone number to be used for sms response Placeholder when no value is specified.
<user>	<APN user name> NA CLR	User name associated with APN. Placeholder when no APN user name is specified. Note that any previously entered user name is maintained. User name is not used.

a. Position SMS response is only for future use, and should be set to NA

Parameter	Values	Meaning
<wakeup>	0 1 NA	Set to NA. This parameter must be present, but is ignored because the EXPLORER 710 does not support wake up functions.
<wanmode>	0 1 2 3 4 5 6 7 8	Cellular modem if available at power-up User selection BGAN only Cellular modem only Not valid for EXPLORER 710 Not valid for EXPLORER 710 Not valid for EXPLORER 710 Not valid for EXPLORER 710 Not valid for EXPLORER 710
<wdog_enable>	0 1 NA	Disabled. Enabled. Placeholder when no value is specified. The existing setting applies. Used if you want to change one of the other parameters without changing the enabled/disabled setting.
<wdog_op>	1 2	Get watchdog configuration. Set watchdog parameters.

SMS reject responses

Reject Response SMS	Possible Cause
ACT/DEACT PARM PROBLEM	The <IP addr> provided for an ACTIVATE or DEACTIVATE command is incorrect (for ACTIVATE, it must be in same subnet as the EXPLORER 710 IP and not be the EXPLORER 710 IP; for DEACTIVATE, it must exist as a local or global IP address in the existing PDP table).
ATCO ERROR	Unable to send AT command to ATC handler.
COMMAND NOT SUPPORTED	Attempt to use an SMS command not supported by the EXPLORER 710.
ERROR: TERMINAL BUSY	An ACTIVATE or DEACTIVATE command is in progress.
INVALID RESTART REQUEST	Attempt to perform restart before EXPLORER 710 has been running for at least 15 minutes.
INVALID WANMODE REQUEST	The requested WAN mode is not supported by the EXPLORER 710, or invalid parameters are used.
INVALID WATCHDOG PING ADDRESS	Entered Ping address is out of range (0.0.0.0 – 255.255.255.254).
INVALID WATCHDOG PING FREQUENCY	Requested Ping Frequency is less than the minimum (5 minutes).
INVALID WATCHDOG REQUEST	"Ping required" or "wdog enabled" fields incorrect in remote SMS message, or watchdog request other than "get" attempted.
WRONG CONNECTION TYPE(NO DHCP TE)	No DHCP TEs connected to the Remote Unit.
WRONG CONNECTION TYPE(NO STATIC TE)	No Static TEs added in Terminal settings.
WRONG CONNECTION TYPE(NO TEs)	No TEs are connected to the Remote Unit.
WRONG PASSWORD	Authentication Failure.
WRONG QOS	Invalid QoS Requested (only a QoS of 1 is valid).

AT commands

The following most used AT commands are explained in this manual. Other AT commands not mentioned here may still be supported.

Note

AT commands related to data connections are only applicable to the BGAN connection, not to the optional cellular connection.

Syntax conventions

Syntax definitions use the following conventions:

- <parm> indicates that a parameter (without < and >) can be filled in by the user.
- { <opt1> | <opt2> | ... } indicates that one of various options must be chosen by the user.
- [<options>] indicates that <options> may or may not be included in the command.

- Keywords and parameters are separated by commas.

Note: If parameters in the middle are left out, the commas must still be there as placeholders, e.g. <parm1>, , , <parm4> - In this case parm 2 and parm 3 are left out, but <parm4> is used. If the last parameters are left out, the commas are not needed, e.g. <parm1>, <parm2>

- The command name and all keywords must be in upper case; most user-provided parameters are case sensitive but may be either case.
- **TE** means Terminal Equipment - the equipment connected locally to the EXPLORER 710.

M2M related AT commands

Note The EXPLORER 710 does not support BGAN M2M SIM cards nor over-the-air software upgrade from the Inmarsat FUP server.

The following tables summarize some of the most used AT commands for M2M operation. Parameters are explained in *Parameters for ATCO commands on page 151* and *Parameters for other M2M related AT commands on page 155*.

ATCO commands

The table below summarizes the ATCO commands, i.e. AT commands that can be used in the SMS command **ATCO**.

Note You can only use SMS commands over the BGAN network, not with a cellular connection.

Command	Parameters
_IATCROBST ^a	<enable>
_ICPWD	<type>,<old passwd>,<new passwd>
_IGETFILE	<ftp dir>,<filename>,<local dir>,<ftp server>,<ftp uname>,<ftp passwd>[,<apn>[,<apn uname>[,<apn passwd>]]]
_IGETFW	<mode>[,<ftp server>[,<ftp uname>[,<ftp passwd>[,<apn>[,<apn uname>[,<apn passwd>]]]]]]]
_IREMWEB	<enable>,<ip_addr_lo>[,<ip_addr_hi>][,<apn>[,<apn uname>,<apn passwd>]]]
_ISENDFILE	<local dir>,<filename>,<ftp dir>,<ftp server>,<ftp uname>,<ftp passwd>[,<apn>[,<apn uname>[,<apn passwd>]]]
_IUPDCFG	<filename>
_IUPDFW	<filename>

a. Robustness for 3GPP LTE signals, not ATC

Parameters for ATCO commands

Parameter	Values	Meaning
<apn passwd>	<apn passwd>	Password for the APN.
<apn uname>	<apn uname>	User name for the APN.
<apn>	<apn>	APN name.
<enable>	0 1	Disable. Enable.
<filename>	<filename>	The name of the file to use, including extension.

Parameter	Values	Meaning
<ftp dir>	<ftp dir>	The name of the directory on the ftp server to use for getting or saving a file.
<ftp passwd>	<ftp passwd>	Password for the ftp server.
<ftp server>	<ftp server>	Host name or IP address of the ftp server.
<ftp uname>	<ftp uname>	User name for the ftp server.
<ip_addr_hi>	<ip_addr_hi>	The upper IP address of a range of allowed IP addresses. This parameter is optional; if omitted, only the specified single IP address <ip_addr_lo> may access the EXPLORER 710.
<ip_addr_lo>	<ip_addr_lo>	IP address of the HTTP client that should be allowed remote access to the EXPLORER 710, or, the lowest address in a range of IP addresses, if a range of addresses is allowed.
<local dir>	<local dir>	The name of the local directory in the EXPLORER 710 to use for getting or saving a file.
<mode>	0 1	Deferred activation. Immediate activation.
<new passwd>	<new passwd>	The new password to be used after this command. The password must be 5 to 15 characters long and cannot contain spaces. Avoid special characters. Accepted characters: A through Z (uppercase characters), a through z (lowercase characters) and 0 through 9 (numeric characters).
<old passwd>	<old passwd>	The old password that is already in the system.
<type>	AD RS	The type of password is administrator password. The type of password is remote SMS password.

ATCO response codes

The following response codes apply to the AT commands supported by SMS.

Code	Text	Explanation
General codes		
0	Complete	Operation completed successfully.
1	Unexpected software error	Software error.
2	Local file open error	_IGETFILE: could not open local file after download. _ISENDFILE: could not open local file. _IUPDCFG: Loading configuration failed. Incompatible file format.
3	Directory not found	Could not find specified directory on local file system.
4	File not found	Could not find specified file name on local file system.
5	Error renaming file	Could not restore after failed upgrade.
Context Management codes		
13	Context activation error	Context activation failed. Could be problem with PS attach, SIM subscription, APN, network or connectivity.
FTP Management codes		
20	FTP hookup fail	Connection to FTP server failed. Problem could be server unreachable or specified IP address or server name invalid, or connectivity failure.
21	FTP login fail	FTP user name or password incorrect.
23	FTP 'cwd' fail	Could not change to working directory on FTP server.
24	FTP data connection fail	Could not establish an FTP data connection with the server.
26	FTP xfer command fail	Could not initiate data transfer on an established connection. May be caused if filename not found.
29	FTP socket fail	Error while reading or writing FTP data socket.
31	FTP xfer timed out	FTP client timed out waiting for socket ready (read or write), e.g. due to loss of connectivity during transfer.
_IGETFW command codes		
40	File in use, cannot download	The file to be downloaded is the same as the image currently in use.
41	Starting immediate upgrade...	Normal success. File downloaded successfully, now starting immediate update.

Code	Text	Explanation
_IUPDFW command codes		
50	New firmware file not found	Could not find specified filename.
51	New firmware file corrupt	New firmware file corrupt.
52	New firmware file failure	The new firmware failed to run or failed to acquire the network and the unit fell back to the old release.
54	Upgrade status file error	Previous update has not finished yet.
_IREMWEB command codes		
81	Global IP: <ip_addr>	Remote connection to web interface is set up successfully. Indicates global IP address assigned to the EXPLORER 710's own PDP context, to which an HTTP connection may be made.

Other M2M related AT commands

Command	Parameters
_ICLCK	<type>,<enable>,<passwd>
_IMACLOC	<enable>,<interface>[,<interface>]
_IMACLOCAD	<action>,<interface>,<MAC Address>[,<MAC Address>] ^a
_ISMSRMT	<enable>
_ITDCIV	No parameters ^b

a. Up to 10 MAC addresses may be specified.

b. Type `_ITDCIV?` to get the input voltage (in mV) of the EXPLORER 710

Parameters for other M2M related AT commands

The table below summarizes the available parameters for the AT commands for M2M operation.

Parameter	Values	Meaning
<action>	0 1	Delete. Add.
<enable>	0 1	Disable. Enable.
<interface>	0	0 means Ethernet interface. This is the only option.
<MAC Address>	<MAC Address>	MAC address(es) for MAC locking. Up to 10 MAC addresses are permitted.
<passwd>	<passwd>	The existing administrator password.

AT commands for message (SMS) configuration

The following AT commands are used for configuration of SMS.

Note For details on parameters for the message configuration commands, see the 3GPP standard ETSI TS 127 005 V4.2.1.

Command	Parameters	Function
+CMGD	<index>	Delete Message.
+CMGF	<mode>	Message Format.
+CMGL	<stat>	List Messages.
+CMGR	<index>	Read Messages.
+CMGS	<da/mr>[,<toda/scts>]	Send Message.
+CNMI	[<mode>[,<mt>[,<bm>[,<ds>]]]]	New Message Indications to TE.
+CPMS	<mem 1>[,<mem 2>[,<mem 3>]]	Preferred Message Storage.
+CSCA	<sca>[,<tosca>]	Service Center Address.
+CSMP	[<fo>[,<vp>[,<pid>[,<dc>]]]]	Set Text Mode Parameters.
+CSMS	<service>	Select Message Service.

Parameters for context management AT commands

The table below summarizes the main parameters for the AT commands for context management. For details, refer to the 3GPP standard TS 27.007.

Parameter	Values	Meaning
<apn passwd>	<apn passwd>	Password for the APN.
<apn uname>	<apn uname>	User name for the APN.
<apn>	<apn>	APN name.
<cid>	<cid>	The Context Identifier (1 – 11) for the PDP context. If no cid is entered, the command applies to all defined PDP contexts.
<d_comp>	0	Data compression off (default if value is omitted)
<destination port range>	<destination port range>	Destination port range in the form From.To To indicate only one port number, type in the same port number under From and To. Example: 65333.65338 indicates port numbers from 65333 to 65338, both included.
<evaluation precedence index>	<evaluation precedence index>	The evaluation precedence index defines the order in which the traffic flow filters are applied to packets. 0 is first, then 1, 2 etc.
<Guaranteed bitrate DL>	<Guaranteed bitrate DL> 0	The guaranteed bit rate down link (32, 64, 128). If the parameter is set to '0' the subscribed value will be requested.
<Guaranteed bitrate UL>	<Guaranteed bitrate UL> 0	The guaranteed bit rate up link (32, 64, 128). If the parameter is set to '0' the subscribed value will be requested.
<h_comp>	0 1	Header compression off (default if value is omitted) Header compression on (manufacturer preferred compression)
<Max bitrate DL>	<Max bitrate DL> 0	The maximum bit rate down link (32, 64, 128). If the parameter is set to '0' the subscribed value will be requested.
<Max bitrate UL>	<Max bitrate UL> 0	The maximum bit rate up link (32, 64, 128). If the parameter is set to '0' the subscribed value will be requested.
<p_cid>	<p_cid>	The primary context to which the secondary context is related.
<packet filter identifier>	<packet filter identifier>	The packet filter identifier (1 – 8).
<PDP_addr>	<PDP_addr>	Omit this parameter - note that the comma must still be there if other parameters come after this one.

Parameter	Values	Meaning
<protocol number>	<protocol number>	This number is uniquely assigned for the protocol being used. TCP is set to 6, and UDP is set to 17. The protocol number determines which protocol is used by the traffic flow filter (0-255).
<source address and subnet mask>	<source address and subnet mask>	This is an IPv4 IP address and subnet mask (0.0.0.0.0.0.0 to 255.255.255.255.255.255.255). The first four numbers are the IP address and the last four numbers are the subnet mask.
<source port range>	<source port range>	Source port range in the form From.To . See <destination port range> for example.
<state>	0 1	Deactivate. Activate.
<Traffic Class>	1 3	Streaming (not available for M2M subscription). Standard data (Background).
<Transfer delay>	0 500 4000	0 ms, error correction is determined by the network 500 ms, error correction is disabled 4000 ms, error correction is applied

Conformity

General

Approvals for the EXPLORER 710 are listed in the display menu of the EXPLORER 710 terminal. Select ****** and then **Properties > Conformity**.

CE

The EXPLORER 710 is CE certified as stated in the simplified “EU Declaration of Conformity”, enclosed in electronic copy at the end of this appendix. The WLAN interface is CE certified through the manufacturer of the WLAN card.

Use of WLAN:

The WLAN interface requires that the user enters the current country of operation. See *WLAN interface setup* on page 63.

IC

This device complies with Industry Canada license-exempt RSS standard(s). Operation is subject to the following two conditions:

- (1) this device may not cause interference, and
- (2) this device must accept any interference, including interference that may cause undesired operation of the device.

Le présent appareil est conforme aux CNR d'Industrie Canada applicables aux appareils radio exempts de licence. L'exploitation est autorisée aux deux conditions suivantes :

- (1) l'appareil ne doit pas produire de brouillage, et
- (2) l'utilisateur de l'appareil doit accepter tout brouillage radioélectrique subi, même si le brouillage est susceptible d'en compromettre le fonctionnement.

This Class [B] digital apparatus complies with Canadian ICES-003.

Cet appareil numérique de la classe [B] est conforme à la norme NMB-003 du Canada.

WLAN:

Under Industry Canada regulations, this radio transmitter may only operate using an antenna of a type and maximum (or lesser) gain approved for the transmitter by Industry Canada. To reduce potential radio interference to other users, the antenna type and its gain should be so chosen that the equivalent isotropically radiated power (e.i.r.p.) is not more than that necessary for successful communication.

Conformément à la réglementation d'Industrie Canada, le présent émetteur radio peut fonctionner avec une antenne d'un type et d'un gain maximal (ou inférieur) approuvé pour l'émetteur par Industrie Canada. Dans le but de réduire les risques de brouillage radioélectrique à l'intention des autres utilisateurs, il faut choisir le type d'antenne et son gain de sorte que la

puissance isotrope rayonnée équivalente (p.i.r.e.) ne dépasse pas l'intensité nécessaire à l'établissement d'une communication satisfaisante.

This radio transmitter (certification number 3913A-APPN551 (Single)) has been approved by Industry Canada to operate with the antenna types listed below with the maximum permissible gain and required antenna impedance for each antenna type indicated. Antenna types not included in this list, having a gain greater than the maximum gain indicated for that type, are strictly prohibited for use with this device.

Le présent émetteur radio (no. de certification 3913A-APPN551 (Single)) a été approuvé par Industrie Canada pour fonctionner avec les types d'antenne énumérés ci-dessous et ayant un gain admissible maximal et l'impédance requise pour chaque type d'antenne. Les types d'antenne non inclus dans cette liste, ou dont le gain est supérieur au gain maximal indiqué, sont strictement interdits pour l'exploitation de l'émetteur.

WLAN antenna types approved for use with the EXPLORER 710:

WLAN antenna for EXPLORER 710, part number 88-139591. Max gain: 1.89 dBi / 50 Ohm.

FCC

Note: This equipment has been tested and found to comply with the limits for a Class B digital device, pursuant to part 15 of the FCC Rules. These limits are designed to provide reasonable protection against harmful interference in a residential installation. This equipment generates, uses and can radiate radio frequency energy and, if not installed and used in accordance with the instructions, may cause harmful interference to radio communications. However, there is no guarantee that interference will not occur in a particular installation. If this equipment does cause harmful interference to radio or television reception, which can be determined by turning the equipment off and on, the user is encouraged to try to correct the interference by one or more of the following measures:

- Reorient or relocate the receiving antenna
- Increase the separation between the equipment and receiver
- Connect the equipment into an outlet on a circuit different from that to which the receiver is connected
- Consult the dealer or an experienced radio/TV technician for help

Part 15.21

Changes or modifications not expressly approved by the party responsible for compliance could void the user's authority to operate the equipment.

EU Declaration of Conformity

Hereby **Thrane & Thrane A/S trading as Cobham SATCOM** declares that the following equipment complies with the specifications of:

RED directive 2014/53/EU concerning Radio Equipment

Equipment included in this declaration

Model	Description	Part no.
TT-3720B	EXPLORER 710 Terminal	403720B

The full text of the EU declaration of conformity is available at the following internet address:

<http://sync.cobham.com/satcom/support/downloads>

RED

Document no.: 99-157450-A

A

APN Access Point Name. The Access Point Name is used by the terminal operator to establish the connection to the required destination network.

B

BGAN Broadband Global Area Network. A satellite network based on geostationary satellites, delivering broadband data and telephony to virtually any part of the earth, with full UMTS (3G) compatibility. BGAN enables users to access e-mail, corporate networks and the Internet, transfer files and make telephone calls.

C

CS Circuit Switched. Circuit-switched networks require dedicated point-to-point connections during calls.

D

DHCP Dynamic Host Configuration Protocol. A protocol for assigning dynamic IP addresses to devices on a network. With dynamic addressing, a device can have a different IP address every time it connects to the network.

F

FCC Federal Communications Commission. An independent agency of the United States government. The FCC works towards six goals in the areas of broadband, competition, the spectrum, the media, public safety and homeland security.

G

GMPCS Global Mobile Personal Communications Services

GNSS Global Navigation Satellite System. A navigation satellite system using the GPS, GLONASS, Galileo or Beidou system.

H

HDR High Data Rate. A BGAN service supporting a portfolio of four new streaming rates, including asymmetric services.

HTTP HyperText Transfer Protocol. HTTP is the underlying protocol used by the World Wide Web. This protocol defines how messages are formatted and transmitted, and what actions Web servers and browsers should take in response to various commands.

HTTPS Hypertext Transfer Protocol Secure (HTTPS) is an extension of the Hypertext Transfer Protocol (HTTP). It is used for secure communication over a computer network, and is widely used on the Internet.

I

IC Industry Canada (French: Industrie Canada) is the department of the Government of Canada with a mandate of fostering a growing, competitive, knowledge-based Canadian economy.

ICMP	Internet Control Message Protocol. An Internet protocol mostly used for diagnostics.
IMEI	International Mobile Equipment Identity. A unique number identifying your terminal.
IMSI	International Mobile Subscriber Identity. A number used to identify the user of a cellular network. It is a unique identification associated with all cellular networks.
IMSO	International Maritime Satellite Organisation. An intergovernmental body established to ensure that Inmarsat continues to meet its public service obligations, including obligations relating to the GMDSS.
IP	Ingress Protection. An international classification system for the sealing effectiveness of enclosures of electrical equipment against the intrusion into the equipment of foreign bodies (i.e. tools, dust, fingers) and moisture. This classification system uses the letters "IP"
IP	Internet Protocol. The method or protocol by which data is sent from one computer to another on the Internet.
IPsec	Internet Protocol Security. A protocol suite for securing Internet Protocol (IP) communications by authenticating and encrypting each IP packet of a communication session.
ISDN	Integrated Services Digital Network. A circuit-switched telephone network system, designed to allow digital transmission of voice and data over ordinary telephone copper wires, resulting in higher quality and speed than are available with analog.
L	
LAN	Local Area Network. A computer network covering a small physical area, like a home, office, school or airport. The defining characteristics of LANs, in contrast to wide-area networks (WANs), include their usually higher data-transfer rates, smaller geographic area, and lack of a need for leased telecommunication lines.
M	
M2M	Machine-to-machine. Direct communication between unmanned devices using any communications channel, including wired and wireless.
MTU	In computer networking, the maximum transmission unit (MTU) of a communications protocol of a layer is the size (in Bytes) of the largest protocol data unit that the layer can pass onwards.
N	
NAT	Network Address Translation. An Internet standard that enables a local-area network to use one set of IP addresses for internal traffic and a second set of addresses for external traffic. A NAT module makes all necessary address translations.
NSD	Network Service Device. An Inmarsat device for routing network traffic between GX and BGAN services
P	
PBX	Private Branch Exchange, telephone exchange that serves a particular business or office.
PIN	Personal Identification Number. A code number used to provide access to a system that

has restricted access.

PoE Power over Ethernet. A standard for combining power supply with transmission of data over the Ethernet. The source unit "injects" power into the Ethernet cable and the power is "picked up" at the connected device.

PPPoE Point-to-Point Protocol over Ethernet. A network protocol for encapsulating Point-to-Point Protocol (PPP) frames inside Ethernet frames. By using PPPoE, users can virtually "dial" from one machine to another over an Ethernet network, establish a point to point connection between them and then securely transport data packets over the connection.

R

RF Radio Frequency. Electromagnetic wave frequencies between 3 kHz and 300 GHz including the frequencies used for communications signals (radio, television, cell-phone and satellite transmissions) or radar signals.

S

SIM Subscriber Identity Module. The SIM provides secure storing of the key identifying a mobile phone service subscriber but also subscription information, preferences and storage of text messages.

SIP Session Initiation Protocol. An application-layer control (signaling) protocol for creating, modifying, and terminating sessions with one or more participants. Used e.g. for Internet telephony.

SPI Security Parameter Index. An identification tag added to the header while using IPsec for tunneling the IP traffic.

SSL Secure Sockets Layer. The standard technology for keeping an Internet connection secure and safeguarding any sensitive data that is being sent between two systems.

T

TE Terminal Equipment - the equipment connected locally to the terminal.

TLS Transport Layer Security. An updated, more secure, version of SSL.

U

UDP User Datagram Protocol. Part of the TCP/IP suite of protocols used for data transferring. UDP is known as a "stateless" protocol, meaning it doesn't acknowledge that the packets being sent have been received. For this reason, the UDP protocol is typically used for streaming media. While you might see skips in video or hear some fuzz in audio clips, UDP transmission prevents the playback from stopping completely.

USB Universal Serial Bus. A specification to establish communication between devices and a host controller (usually personal computers). USB is intended to replace many varieties of serial and parallel ports. USB can connect computer peripherals such as mice, keyboards, digital cameras, printers, personal media players, flash drives, and external hard drives.

UTC Coordinated Universal Time. The International Atomic Time (TAI) with leap seconds added at irregular intervals to compensate for the Earth's slowing rotation. Leap seconds are used to allow UTC to closely track UT1, which is mean solar time at the Royal Observatory, Greenwich.

W

- WAN** Wide Area Network. A telecommunications network or computer network that extends over a large geographical distance. In this manual, WAN is the external network via BGAN or cellular connection, whereas LAN is used for the local connection of equipment to the terminal.
- WLAN** Wireless Local Area Network.

Numerics

- 2-wire
 - connect a phone, 24
 - connector, 137

A

- AC/DC adapter specifications, 136
- access
 - remote, 37
- access to settings
 - limit in web interface, 93
- access using AT commands, 37
- admin password
 - change, 93
 - disable, 92
 - enable, 92
 - log in, 92
 - log out, 93
 - reset, 72
- advanced settings, 92
- alerts
 - view in display, 46
 - view in web interface, 70
- Alphasat
 - frequencies, 141
- analog phone
 - connect, 24
- antenna
 - connect, 15
 - connector, 141
 - detach, 11
 - fixed, 29
 - point, 17
 - separate from transceiver, 11
 - short description, 7
- APN
 - set up for BGAN, 80
- app for smartphone connection, 9
- AT commands
 - access with IP, 37
 - list of, 143
 - remote access with IP, 41
- audio assisted pointing, 18
- automatic activation, 81
- automatic shut down
 - connection, 99

B

- backup configuration, 96
- bandwidth
 - extend by bonding, 33, 77
- battery
 - capacity display accuracy, 117
 - charge, 116
 - discharged, 116
 - hot-swap, 117
 - insert, 12
 - precharge, 116
 - remove, 13
 - safety, iv
 - short description, 7
- BGAN network
 - startup mode, 74
- BGAN profile, 108
- bonding, 33
 - set up terminals, 77
- bridge mode, 76
- brightness in display, 46

C

- call charges
 - estimating in web interface, 99
- call log, 61
- calls
 - make, 42
 - missed, received, outgoing, 61
 - total usage, 62
- CE compliance, 160
- cellular network
 - overview, 17
 - set up, 110
 - startup mode, 74
- channel bonding, 33
 - set up terminals, 77
- charge
 - EXPLORER 710 batteries, 116
 - smartphone or tablet, 46
- charges for calls
 - estimating, 99
- command reference, 143

- configuration
 - copy, 96
 - IP handsets and smartphones, 68
 - ISDN, 65
 - LAN, 63
 - phone interface, 64
 - save or load, 96
 - USB, 65
 - WLAN, 63
- conformity, 160
- connect a phone
 - Phone interface, 24
 - WLAN or LAN, 22
- connect interfaces
 - LAN, 21
 - WLAN, 20
- connect power, 15
- connected devices
 - manage, 66
- connection
 - automatic shut down, 99
- connection packages
 - multiple connections, 82
- connection watchdog, 96
- connections
 - dedicated, 87
 - multiple, 82
- connectors, 14
 - antenna, 141
 - DC input, 136
 - ISDN, 138
 - LAN, 139
 - Phone, 137
 - USB Host, 140
- Control panel, 60

D

- data
 - limits, set, 99
 - log, 61
 - Standard, definition, 33
 - start or stop connection, 28, 33
 - Streaming definition, 33
 - total usage, 62
- data connections
 - dedicated, 87
 - start and stop in display, 28
 - start and stop in web interface, 55
- DC input
 - connect, 15
 - connector, 136

- dedicated connections, 87
- default IP address, 50
- delivery contents, 8
- detach the antenna, 11
- devices
 - manage, 66
- diagnostics report
 - create, 71
- disable interfaces, 31
- discharged battery, 116
- display
 - adjusting brightness, 46
 - change language, 47
 - menu overview, 6
 - navigation, 5
 - overview, 5
- disposal, 118

E

- enable interfaces, 31
- Ethernet connector, 139
- Event log, 70
- EXPLORER Connect app
 - check software version, 9
 - overview, 9
- extended L-band
 - frequencies, 141

F

- factory settings
 - restore, 94
- FCC compliance, 160
- fixed installation, 29
- forward port, 90
- frequencies
 - extended L-band, 141
 - I-4, 141

G

- GNSS
 - select system, 78
 - troubleshooting, 121

H

- hot-swap EXPLORER 710 batteries, 117
- HTTP, redirect to HTTPS, 109

I

- I-4
 - frequencies, 141

IC compliance, 160
IMEI number, 47
included items, 8
indicator, Status LED, 125
initial inspection, 8
insert battery, 12
insert SIM card, 12
interfaces
 enable or disable, 31
Internet connection mode
 setting, 76
IP address
 for web interface, 50
 local, setting up, 76
IP connection
 monitoring, 96
IP handset
 connect, 22
 manage in the terminal, 68
 SIP settings, 23
 Thrane IP Handset, 45
 user name and password, 68
ISDN
 configure, 65
 connect phone or modem, 25
 connector, 138
items included, 8

L

LAN
 automatic activation of, 81
 configure, 63
 connect a computer, 21
 connect an IP handset, 23
 connectors, 139
LAN or WLAN
 automatic activation of, 81
language
 change in display, 47
 change in web interface, 78
latch for transport, 10
LED on front panel, 125
light indicator, 125
limit
 allowed kB, 99
 allowed time, 99
 data, 99
limiting user access, 93
link monitoring, 96
load configuration, 96

log
 of calls, 61
 of data connections, 61
 of events, 70
log in as administrator, 92
log out as administrator, 93

M

MAC address
 connected devices, 66
manage connected devices, 66
maximum for data, 99
menu in display, 6
monitoring the external IP connection, 96
monitoring the terminal, 97
multiple data connections, 82

N

navigation
 display, 5
navigation in web interface, 52
network
 cellular or BGAN, 17
 select startup mode, 74

P

password
 change, 93
 disable, 92
 enable, 92
 log in, 92
 log out, 93
 reset, 72
 smartphone or IP handset, 68
permissions
 setting for users, 93
phone
 configure, 64
 connect to LAN or WLAN, 22
 connect to Phone interface, 24
 connector, 137
 SIP settings, 23
phone call, 42
PIN
 changing for BGAN, 94
 changing for cellular network, 95
 enabling or disabling for BGAN, 94
 enabling or disabling for cellular network, 95
 enter in display, 16
 enter in web interface, 53

ping command from the terminal, 96
point the antenna, 17
point the antenna again, 19
pointing
 audio assisted, 18
pointing process
 restarting, 19
port forwarding, 90
position
 troubleshooting, 121
power
 connecting, 15
Power connector, 136
power supply
 AC/DC adapter, 136
precharging battery, 116

R

recovery
 software, 115
remote management
 access using AT commands, 41
 access using web interface, 38
 activation with SMS, 37
 preparation, 40
 set up in web interface, 100
remove battery, 13
remove SIM card, 13
repoint the antenna, 19
report
 diagnostics, 71
restore factory settings, 94
rights for users
 in web interface, 93
router mode, 76

S

safety summary, iii
save configuration, 96
separate antenna form transceiver, 11
settings
 in web interface, 60
 limit access, 93
 restore, 94
SIM card
 insert, 12
 remove, 13
 short description, 7
SIM lock, 121
SIP settings, 23

smartphone
 charge via USB, 46
 connect for calls, 22
 manage in the terminal, 68
 SIP settings, 23
 user name and password, 68
SMS
 activate data connection, 37
SMS commands, 145
 list of, 143
 parameters summary, 146, 158
 summary, 145
software
 recovery, 115
 update with USB, 114
 update with web interface, 71
 view current EXPLORER 710 version, 47
 view current EXPLORER Connect app version, 9
sound during pointing, 18
Standard data
 definition, 33
start data connection, 28, 33
Status
 view in web interface, 58
storage, 118
Streaming data
 definition, 33

T

tablet
 charge via USB, 46
Terminal watchdog
 setup in web interface, 97
Thrane IP Handset
 enable or disable, 108
total usage, 62
tracking the terminal, 47
 setup in web interface, 88
Traffic control, 66
transport latch
 opening, 10
troubleshooting, 119
troubleshooting guide, 119
typography used in this manual, vi

U

update software, 71
 USB, 114
usage
 calls and data, 62

USB

- charge smartphone or tablet, 46
 - configure, 65
 - connector, 140
 - update software, 114
- user name
- smartphone or IP handset, 68
- user permissions
- setting up in web interface, 93

W

- warning messages, 46, 70
- warranty, 112
- watchdog
- connection, 96
 - terminal, 97
- web interface
- accessing, 50
 - change language, 78
 - definition, 50
 - navigating, 52
- what's in the delivery, 8
- WLAN
- automatic activation of, 81
 - configure, 63
 - connect to, 20

