



**LT-4100L SATELLITE  
COMMUNICATIONS SYSTEM**  
**IRIDIUM CERTUS® 100 LANDMOBILE**  
(FIXED INSTALLATION)

## FIXED INSTALLATION



## LT-4100L IN SHORT

- 2 x Voice Channels (high quality)
- IP-data: 22 kbps (up) / 88 kbps (down)
- High-performance GNSS/GPS receiver
- Single antenna cable solution (up to 500 m)
- Support for external SIP PABX and SIP handsets (up to 8)
- Firewall and user authentication for high level of security
- Web server for configuration and maintenance

## PRODUCT DESCRIPTION

The LT-4100L Satellite Communications System (Iridium Certus® 100) is a LandMobile satellite communication product from Lars Thrane A/S. The LT-4100L system is designed for fixed installation only. The LT-4100L system has voice and data capabilities with 100% global coverage provided by the Iridium® Network. The LT-4100L system consists of a control unit, antenna unit, handset, and cradle. The LT-4100L system offers 2 high quality voice channels, and IP-data 22 kbps (up) / 88 kbps (down), making it the perfect satcom communication product for any fixed installation.

## PRODUCT FEATURES

### VOLUME CONTROL

Handset speaker volume control button

### RINGER

Incoming call ringer

### MICROPHONE

High-quality microphone

### COLOR DISPLAY

Large 4.3" TFT display supporting brightness adjustment and day/night mode themes

### KEYPAD

Responsive keypad with brightness adjustments

### AUDIO SPEAKER

Audio speaker supporting key beep, voice prompt, and alarms

### FUNCTIONAL KEYS

Functional keys; off-hook, on-hook, navigation, and soft keys



# INTERFACES

## ETHERNET

Ethernet LAN (RJ45). Connectivity for data, Voice (SIP), service and maintenance

## CHASSIS GROUND

Chassis ground connector

## ANTENNA

Coaxial type-N conn (female). One cable solution supporting power and communication to the antenna



## SIM CARD

SIM card behind rubber dust cover for easy insertion and replacement

## AUXILIARY

Auxiliary (10-pin) supporting RS-422, and external ringer

## POWER

12 - 24 VDC

# INSTALLATION OPTIONS

## ANTENNA MOUNTING KITS

## CONTROL UNIT MOUNTING KITS



Pole Mount  
(1.5" pipe, Ø38.8mm)  
Antenna Unit



Pole Mount  
(2.0" pipe, Ø53.0mm)  
Antenna Unit



Bracket Mount  
Control Unit

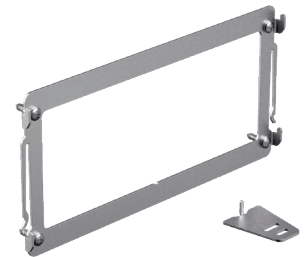

Flush Mount  
Control Unit

# SYSTEM CONFIGURATION



Spiral cord

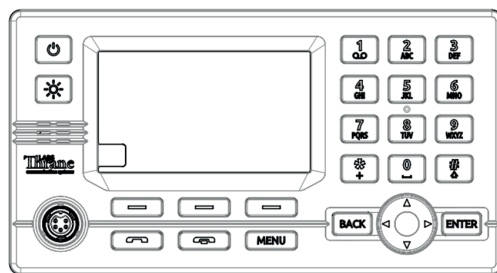

LAN

AUX

PWR

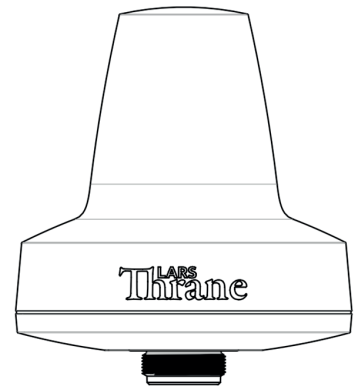

Antenna coaxial cable

Up to 500 m

# SPECIFICATIONS

## LT-4100L SATELLITE COMMUNICATIONS SYSTEM

Certification & standards	CE, FCC, ISED, RED, RoHS 2, Iridium®
Vibration, operational	IEC 60945
Vibration, shock	Half sine 20 g/11 ms
Compass Safe Distance, std.	0.3 - 1.4 m (1.0 - 4.6 ft)
Compass Safe Distance, steer.	0.3 - 0.9 m (1.0 - 3.0 ft)
Power consumption: operating mode, max	24 W
Power consumption: Idle	9 W

### LT-4110 Control Unit

Weight	0.67 kg (1.48 lbs)
Dimensions	224.0 x 120.0 x 70.0 mm (8.82 x 4.72 x 2.76 in)
Temperature, operational	-15°C to +55°C (+5°F to +131°F)
IP rating, dust and water	IP32
Interfaces	Ethernet, auxiliary, DC input, chassis ground Antenna Unit (N conn.), handset, SIM card
Input power	12-24 VDC (2.0-1.0 A)*

### LT-3120 Handset Unit

Weight (handset + wire)	0.30 kg (0.66 lbs)
Dimensions	52.8 x 208.8 x 38.2 mm (2.08 x 8.22 x 1.50 in)
Temperature, operational	-15°C to +55°C (+5°F to +131°F)
IP rating, dust and water	IP32

### LT-4130L Antenna Unit

Weight	1.39 kg (3.05 lbs)
Dimensions	182 x Ø 162 mm (7.16 x Ø 6.39 in)
Temperature, operational	-40°C to +55°C (-40°F to +131°F)
IP rating, dust and water	IP67
Interfaces	Control Unit (N conn.)
Antenna communication cable	Coaxial cable, up to 500 m (1500 ft)
Warranty	2 years
Maintenance	None

\* When 12 VDC input power is used, the maximum cable length will be reduced and thus less power.

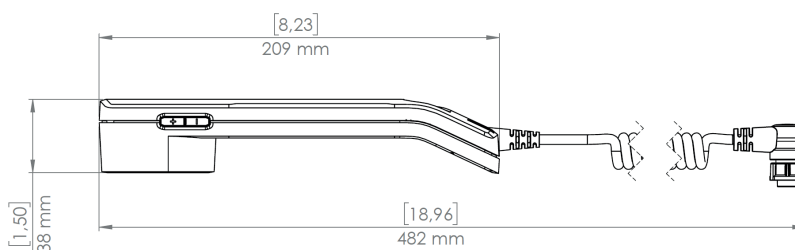
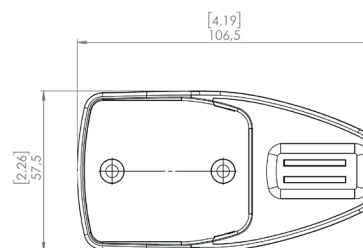
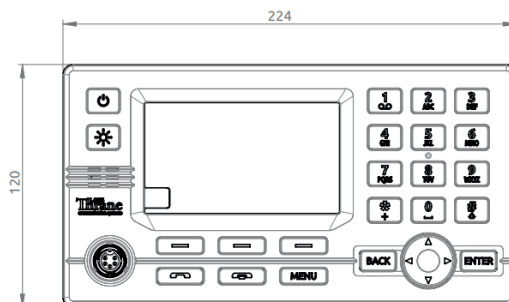
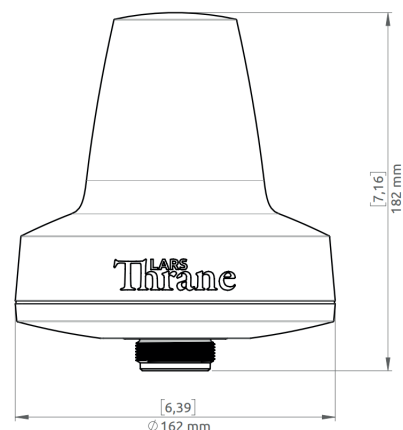

## IN THE BOX

LT-4110 Control Unit	P/N: 51-102663
LT-3120 Handset	P/N: 51-100988
LT-3121 Cradle	P/N: 51-101181
LT-4130L Antenna Unit (LandMobile)	P/N: 51-102827
Bracket Mount, Control Unit	P/N: 91-100771
Power Cable, 3m	P/N: 91-102118
User & Installation Manual	P/N: 95-102576

## ACCESSORIES

Flush Mount, Control Unit	P/N: 91-100772
Pole Mount (1.5" pipe, Ø38.8mm), Antenna Unit	P/N: 91-100774
Pole Mount (2.0" pipe, Ø53.0mm), Antenna Unit	P/N: 91-102550
Auxiliary Cable, 3m	P/N: 91-100768
Coaxial Cable Ø4.9mm (up to 100m)	
Coaxial Cable Ø10.3mm (up to 500m)	
Crimping Tool for Coaxial Cable Ø4.9mm and Ø10.3mm	



Lars Thrane A/S  
 Skovlytoften 33  
 DK-2840 Holte, Denmark  
 Phone: +45 88 30 10 00 Fax: +45 88 30 10 09  
 Email: sales@thrane.eu  
 CVR DK-36042443  
 www.thrane.eu